



MEGADYNE



***ENGINEERED
& SPECIALTY
BELT***

FAMILY PRODUCT
GUIDE

EN



WE ARE MEGADYNE	2
INDUSTRY APPLICATIONS AT GLACE	4
Food	5
Packaging industry	6
Other industries served	7
COVERS	9-41
Polyurethane	11
PVC	17
Natural Rubber	21
Nitrile - Neoprene	29
Polychloroprene	31
EPDM - Viton - HNBR	34
Others	36
Silicone	38
Product Example Gallery	39
Covers Worksheet	40
MODIFICATIONS	42-48
Cleats	44
Cleats Worksheet	46
MEGAC4T & False Teeth	47
Progressive Pin Joint System (PPJ)	48
ENGINEERED SOLUTIONS	49-52
Hybrid Belts	52

WE ARE **MEGADYNE**

Welcome to Megadyne, where innovative power transmission solutions drive operational excellence. Our products help customers achieve peak performance, empowering your business to maximize efficiency.

MATHI, ITALY



ABOUT US

Our skilled designers and engineers are crucial to delivering innovative Megadyne power transmission solutions. As field experts, they thoroughly analyze and study industrial processes to develop new solutions and enhance existing ones.

Remaining a local power transmission brand while expanding our global reach has enabled us to become a market leader. Our products are designed to meet your needs firsthand, providing effective solutions worldwide.

Sustainable solutions are more important than ever for Megadyne. Our brand is represented by people who care for the environment and are committed to preserving it for future generations. That's why our products are designed to last longer, save energy, and reduce our customers' overall carbon footprint.



8 

FACTORIES IN EUROPE,
ASIA AND AMERICA

+170 

COMMERCIAL LOCATIONS

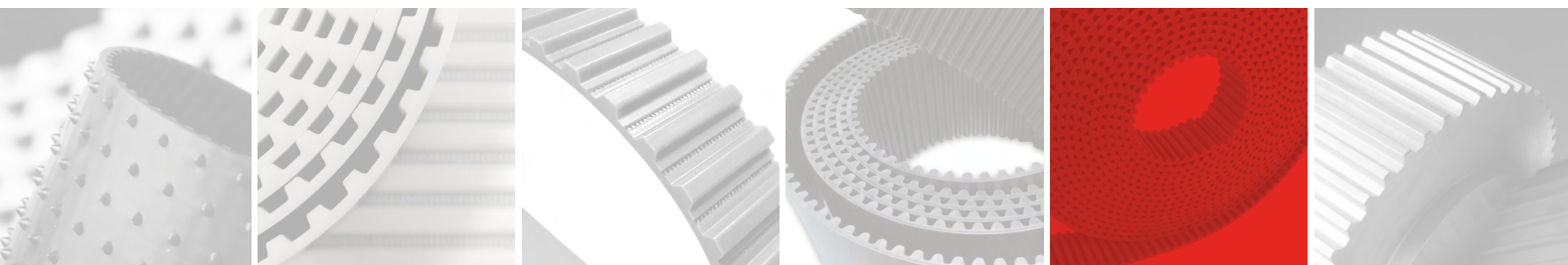

OUR REACH

After decades of growth, Megadyne continues to excel with a diverse portfolio of comprehensive power transmission and product handling solutions for all industry segments.

Our extensive product portfolio is available globally in over 40 countries and 170 locations to support our OEM and SEM clients' businesses in their sustainability efforts. Alongside AMMEGA brands like Ammeraal Beltech in conveyor belting and Jason Industrial in fluid power, we share core values of customer centricity, people focus, entrepreneurship, agility, and responsibility. Together, we provide unique applications, fluid power solutions, and belting solutions for the entire supply chain.

1957



OUR SOLUTIONS

Our customers include original equipment manufacturers and aftermarket distributors, for whom we deliver a wide range of products. Our offerings include thermoset and thermoplastic polyurethane belts, rubber timing and V-belts, flat belts, multi-rib belts, engineered/specialty belts, pulleys, clamping plates, timing bars and complementary products that can be customized for your application.

Engineered belts are the pride of Megadyne. Customers who purchase our fabricated solutions first experience the expertise of our professionals and are then amazed by the final product. Each fully customized power transmission belt, complete with all accessories, is precisely tailored to meet the exact requirements of the customer's application.



Welcome to Megadyne **Power Transmission Solutions**

Megadyne supplies complete and innovative solutions for broad applications and industries such as **material handling, elevators, machine tools, food industry equipment, packaging, fitness, wood, marble, and ceramics...** just to name a few of the many industrial markets where you'll find the Megadyne name.



MATERIAL
HANDLING



ELEVATORS
& LIFTS



MACHINE
TOOLS



PACKAGING



FITNESS



WOOD



FOOD



MARBLE
& CERAMICS

WE MAKE
YOUR
BUSINESS
MOVE

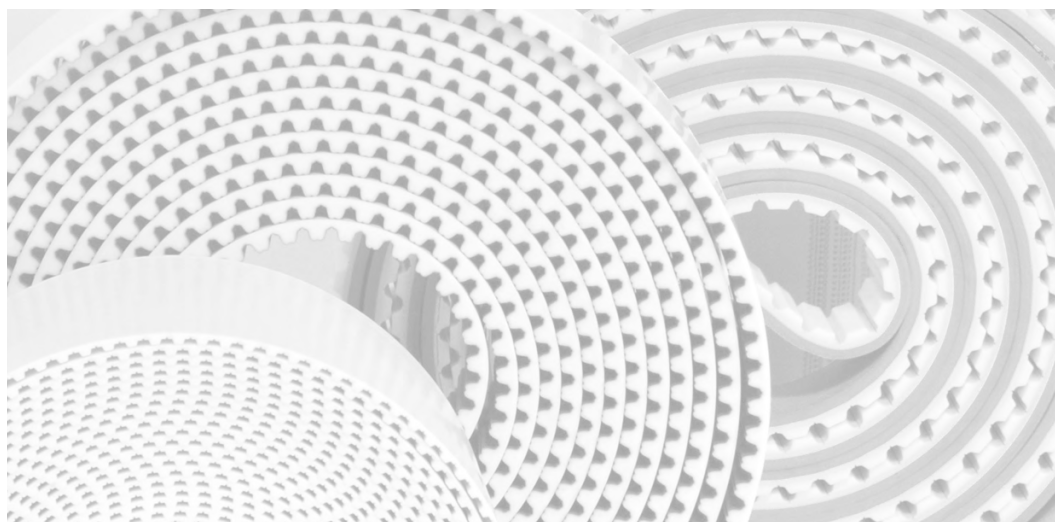



INDUSTRY APPLICATIONS AT GLANCE

FOOD INDUSTRY
PACKAGING INDUSTRY
OTHER INDUSTRIES

FOOD INDUSTRY

FOOD-APPROVED MATERIALS IN HIGH-SPEED AND PRECISION HANDLING APPLICATIONS

Megadyne offers a range of belts offering high-speed and precision handling performance, made by FDA materials and EU approved certifications, designed to offer a high-end solution for any food handling applications.

MAIN APPLICATIONS

- Meat Slicing
- Inspection Line
- Vertical Form Fill and Seal
- Horizontal Form Fill and Seal
- General Conveying
- Sausage Belts



Additionally, Megadyne offers a wide variety of cover materials, which are food approved. We have diverse Thermoplastic PU, PVC, Rubber, and Silicone covers applicable for any kind of food application. Combining the belts with an additional cover does not meet the same standards as the base belt. Contact Megadyne for more information.



RECOMMENDED PRODUCTS

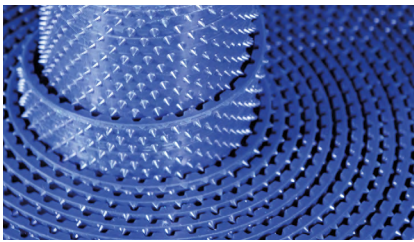

MEGALINEAR FC

New to the MEGALINEAR family, and introduced for food processing and packaging applications, MEGALINEAR FC is manufactured with food-contact approved materials, according to European regulations EU 1935/2004, EU 10/2011, and EU174/2015. MEGALINEAR FC is manufactured in T5/T10 pitch without gap between the teeth and is available in a smooth surface or backing profiles, such as Spike Top, Noppen, and others, for all kinds of conveying and processing applications. These advanced food-contact synchronous belts have excellent resistance to chemicals and corrosion and are designed for use in wet and dry food-contact applications. The homogeneous belt design ensures a significantly greater service-life with a high-level of hygienic integrity.

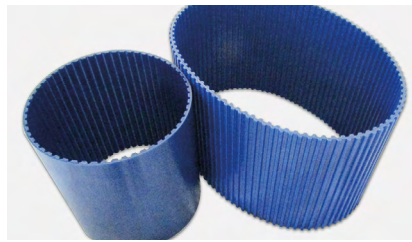

MEGAPOWER FC

Designed for power transmission and certain synchronous conveying applications within the food and packaging industry where the polyurethane chemistry is beneficial for oily environments and where rigorous wash down procedures are common. Featuring stainless steel cords and food-compliant blue polyurethane according to European regulations EU 1935/2004, EU 10/2011, and EU174/2015, MEGAPOWER FC is ideal for both wet and dry applications thanks to its good chemical and corrosion resistance in humid and wet environments. MEGAPOWER FC handles your high acceleration, multi stop/start synchronous food product handling drives with ease.

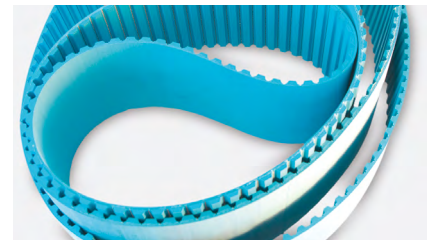

FCM BELTS

MEGALINEAR FCM and MEGAFLEX FCM are available in Light Blue Thermoplastic PU and stainless-steel cord. This combination conforms to an FC approval for the belt according to EC 1935/2004. Kevlar® cords. They are available for MEGALINEAR FCM with T10 and AT10 without gap.

Thanks to the belt construction and cord pitch, FCM belts are also suitable for heavy load conveyor and power transmission applications, for example linear units for Food processing.



Visit www.megadynegroup.com for more information on our product offering in the Food Industry.

ENGINEERED &
SPECIALTY BELTS

PACKAGING INDUSTRY

CUSTOMERS RELY ON MEGADYNE'S FULL LINE OF BELTING SOLUTIONS FOR THE PACKAGING INDUSTRY, INCLUDING A WIDE RANGE OF STANDARD AND CUSTOMISED PRODUCTS

Megadyne provides its customers with innovative solutions to specific Packaging Industry needs, offering a wide selection of belt constructions and manufacturing processes thanks to years of industrial experience. Megadyne products are used in packaging equipment from the start to the finish of the packaging line.

Our portfolio of synchronous and non-synchronous belts, including special cover materials, cleated belts, machined modifications, and other fabrications types, deliver the solutions for a wide variety of applications including:

- Carton forming/box erecting/box closing
- Filling
- Blow molding machines
- Capping lines
- Cartoning lines
- Check weighing
- Feed lines
- Filling lines
- Form, fill, and seal
- Wrapping and sealing
- Labeling

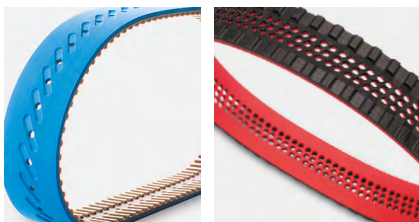
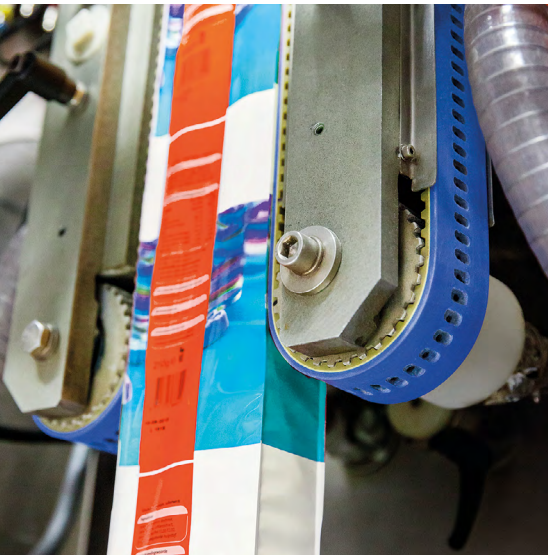
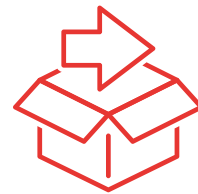

VERTICAL FORM FILL SEAL BELTS

- Homogeneous moulded covers that provide uniform wear surfaces free of hard spots to increase performance
- Covers without any splices or seams for increased reliability
- Continuous, durable wearing covers that provide consistent friction for life of the belt
- Non-glazing compounds that offer excellent grip and slip prevention
- Excellent abrasion resistance for an increased trouble-free lifespan
- Excellent flexibility without cracking or tearing
- Standard OEM replacement belts for all major manufacturers
- CNC machined precision modifications such as slots, countersunk holes, grooves, and profiles within precise tolerances for outlasting performance
- Metal Sealing Bands available



IN-LINE FILLING BELTS

After filling of liquids, capsules, and pills; capping machines apply, tighten and secure caps of varying material types to bottles. and containers made of glass, PET, PVC, PP, LDPE, and HPDE.

Capping machines are used to complete the packaging of food products, beverages, household products, pharmaceuticals, and industrial goods. Megadyne's Specialty Belt Division can manufacture the correct frictional and cushioning types of belts to apply torque and twisting motion to securely lock the cap in place.



FOOD PACKAGING

On the Food Packaging, MEGALINEAR timing belts - joined with PPJ joint system and equipped with FDA cleats - exceed the performance of non-synchronous flat belts and guarantee the most efficient product separation without belt slippage, lack of synchronization, expensive downtime, high-cost of spare parts.

ENGINEERED &
SPECIALTY BELTS



Visit www.megadynegroup.com for more information on our product offering in the Packaging Industry.

OTHER INDUSTRIES

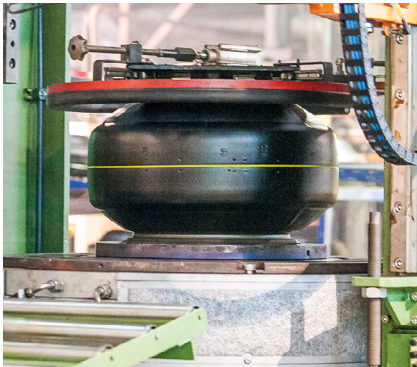
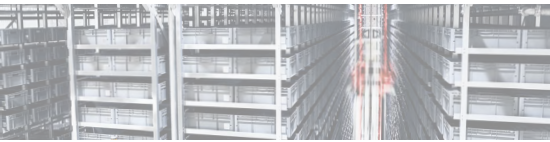

AUTOMOTIVE & TYRE

Working hand in hand with our partners in the Automotive and Tyre industry led us to create belts for vacuum, magnetic applications, the transport of raw-rubber, and metal stock. Our customised belts serve different applications, ensuring excellent cut and wear-resistance, high-strength for lifting, good oil and chemical resistance, low friction for accumulation, and non-marking high grip where needed.

- Sheet Metal Processing
- Glass tempering line and storage
- Car chassis assembly
- Skid conveyors applications
- Tyre manufacturing

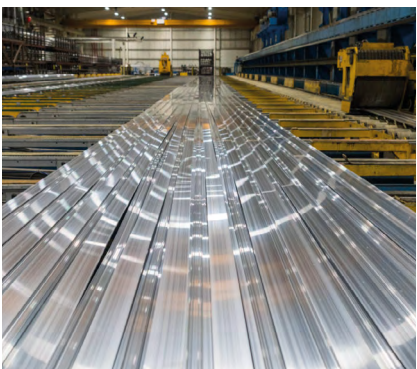

ALUMINUM EXTRUSION

Our belting products are used in a wide range of applications to ensure materials are transported successfully throughout each stage of aluminium production. Megadyne offers tailored solutions to meet your handling requirements such as non-marking surfaces and high-temperature product handling.



CERAMIC, GLASS, BRICK & STONE

Megadyne offers urethane and rubber materials that can be fitted to your application. We offer high-friction and excellent wear-resistance as well as cover modifications to assist in product handling, such as holes and angular or lateral machining.

- Grinding Machines
- Cutting Lines
- Beveling Lines
- Drilling Lines
- Polishing Lines
- Tempering Lines
- Sealing Lines



MATERIAL HANDLING

High-strength and precision repeatability are essential components required in lift movement and material handling. With a broad range of urethanes and cord options, Megadyne can supply the right belt for your application.

- Live Roller Conveyors
- Cross Sorters
- Pallet and Transport Platform Conveyors
- Gapping Conveyors
- Incline Conveyors
- Line Conveyors
- Diverters
- Offload, Sorting and Delivery Conveyors
- ASRS Systems

ENGINEERED &
SPECIALTY BELTS

OTHER INDUSTRIES



MEDICAL INDUSTRY

Megadyne offers several synchronous and non-synchronous clean running options for both light-duty power transmission, positioning, and product handling applications.

- Medical Equipment:
 - MRI Tables
 - Blood Centrifuge
- Automated Pharmaceutical Dispensers
- Medical Instrumentation

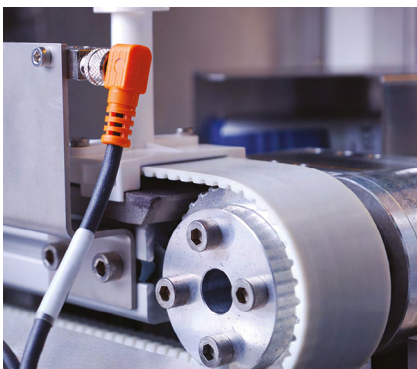

ROBOTICS & AUTOMATION

Urethane and rubber high-strength synchronous belts are being increasingly incorporated into robotic positioning applications; these commonly include pick and place systems, and applications where positional accuracy is required.

- 3D Printing
- Fiber Optics
- X,Y Drives
- Swimming Pool Cleaners
- Security Camera Positioning
- Theatre Lighting Positioning
- Automotive Assembly Welding Systems



PAPER & PRINT

From a broad range of elastomer options, Megadyne can provide the right combination of substrate and cover materials to yield wear-resistance, the right coefficient of friction, and antistatic requirements. Megadyne specializes in modifications such as holes or slots, counter slots, and vacuum draws.

- Banking Equipment
- Printing Equipment
- Bindery Equipment
- Mail Handling Equipment
- Collating Machines
- Ticketing Machines
- Newspaper Equipment
- Personal Hygiene Products - Diapers, Wipes



WOOD

Within the Wood Industry, Megadyne is able to meet all requirements - even the most challenging - with standard and specialty belts.

- Veneer Stacker
- Plywood Layup & Pressing
- Press Exit, Trimming & Inspection
- Wood Panel Conveyor

ENGINEERED &
SPECIALTY BELTS

... AND MANY MORE...

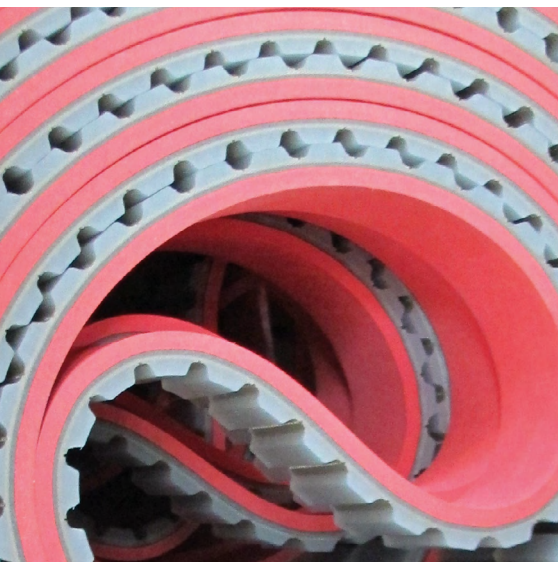

COVERS

POLYURETHANE
PVC
NATURAL RUBBER
NITRILE-NEOPRENE
POLYCHLOROPRENE
EPDM-VITON-HNBR
OTHER COATING
SILICONE

ENGINEERED &
SPECIALTY BELTS

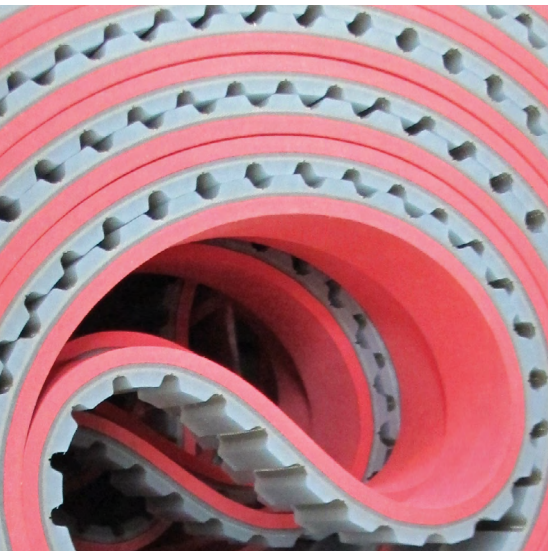

COVERS

MEGADYNE IS A GLOBAL LEADER IN THE DESIGN AND MANUFACTURING OF SPECIALTY AND ENGINEERED BELTS WITH COVERS

Why is this the case? It starts with our understanding of polymers. From rubber to silicone, to urethane, to impregnated fabrics, internal knowledge at Megadyne as well as that obtained from our other AMMEGA sister companies is matched with our broad process offering.

At Megadyne, we mould rubber, spin cast urethane, and Hytrel®, apply silicone and neoprene coating, spray urethane foam, and laminate materials made of urethane, PVC, rubber, fleece, artificial leather, silicone, and Kevlar®.

With our vertically integrated business model, matched with our multiple manufacturing processes, and state-of-the-art modification equipment, Megadyne is well positioned to offer you high-quality, consistently produced products. No one manufacturer of Engineered Specialty belts provides more solutions.

PRODUCT AVAILABILITY

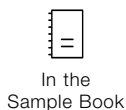

RESISTANCE¹ QUALITY LEVELS

Poor	●○○○
Fair	●●○○
Good	●●●○
Very Good	●●●●

¹ In relation to Water, Abrasion and Oil Resistances of the cover material.

COVER COLOUR KEY

● Orange	● Yellow	● Blue FDA
● PU Cream	● White	● High Duro Pink
● PU Blue	● Tan	● Dark Gray
● Gray	● Sylomer Blue	● Royal Blue
○ Transparent	○ Transparent Brown	● Black
● Red Grip	● Celloflex Tan	● Dark Red
● Red	● Dark Green	● Brown
● Mint Green	● Blue Anti Glaze	● Coral

IMPORTANT COVER INFORMATION

The following information provides explanation for the asterisk found within the cover section (8-34).

***Coefficient of Friction (CoF):** Determined by the static value against a steel guide; however, consideration must be given to the specific environmental conditions (contamination and/or wear resistance) and aging on the cover

****Oil Resistance:** Dependant upon the exact chemical nature and viscosity of the oil

*****Ground Covers** can yield a tighter tolerance of +/-0.3mm if required

******Minimum Pulley Diameter (Pd) = desired cover thickness x given multiplier: i.e. 2mm cover thickness x 30 (given) = 60mm min. Pd. If the minimum diameter of base belt is larger than the calculated cover minimum Pd, use the larger of the two values.**

*******Minimum Pulley Diameter (Pd) = Total Belt Thickness (TK)x5**

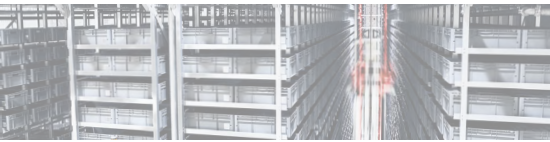

COVERS: POLYURETHANE

	AVAFC 60	AVAFC 70	AVAFC 85
	<p>PU 1</p>	<p>PU 2</p>	<p>PU 3</p>
SOURCE LOCATION	ITALY, USA	ITALY, USA	ITALY, USA
COLOURS	○	○	○
RAW MATERIAL	PU	PU	PU
HARDNESS (ShA)	60	70	85
COVER AND BELT COHESION METHOD	CO-EXTRUSION	CO-EXTRUSION	CO-EXTRUSION
STANDARD COVER THICKNESS RANGE (mm)	2/3/4	2/3/4	2/3/4
TOLERANCE COVER THICKNESS (mm)	+/- 0.3	+/- 0.3	+/- 0.3
WORKING TEMPERATURE (°C)	-20 /+80	-20 /+80	-20 /+80
COEFFICIENT OF FRICTION* (CoF)	0.65	0.65	0.60
MIN. PULLEY DIAMETER	x 40	x 40	x 40
WATER RESISTANCE	●●●○	●●●●	●●●○
ABRASION RESISTANCE	●●●○	●●●○	●●●●
OIL RESISTANCE**	●●●○	●●○○	●●●○
FEATURES/BENEFITS	High-friction on smooth and dry surfaces. Available in different colour under respecting a MOQ.	High-friction on smooth and dry surfaces. Available in different colour under respecting a MOQ.	Very good wear-resistance. Suitable for conveying sharp-edged materials.
FOOD CONTACT APPROVED	NO	NO	NO
FDA APPROVED			
EU REGULATIONS			

INDUSTRIES



ENGINEERED & SPECIALTY BELTS



COVERS: POLYURETHANE

PU FISHBONE

PU RIBBED

NP 385

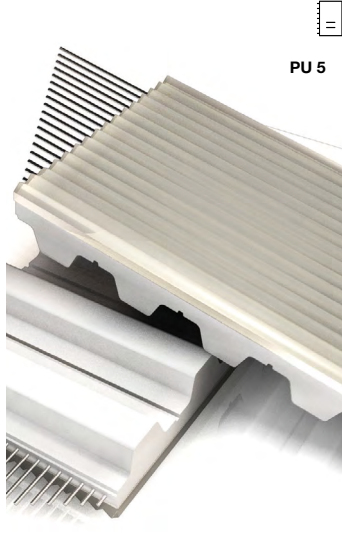

SOURCE LOCATION	ITALY, USA	ITALY, USA	ITALY
COLOURS	○	○	○
RAW MATERIAL	PU	PU	PU
HARDNESS (ShA)	70	70	70
COVER AND BELT COHESION METHOD	CO-EXTRUSION	CO-EXTRUSION	CO-EXTRUSION
STANDARD COVER THICKNESS RANGE (mm)	4.3	2.7	4
TOLERANCE COVER THICKNESS (mm)	+/- 0.5	+/- 0.5	+/- 0.3
WORKING TEMPERATURE (°C)	-20 /+80	-20 /+80	-20 /+80
COEFFICIENT OF FRICTION* (CoF)	0.60	0.60	0.60
MIN. PULLEY DIAMETER	x 30	x 35	x 40
WATER RESISTANCE	●●●●	●●●●	●●●○
ABRASION RESISTANCE	●●●○	●●●○	●●●●
OIL RESISTANCE**	●●○○	●●○○	●●●○
FEATURES/BENEFITS	Suitable for wet environments where friction and drainage are necessary.	Reduced contact point for conveying smooth products. Allows drain of liquids.	For oily conveyor conditions. Contact only on top of the Noppen.
FOOD CONTACT APPROVED	NO	NO	NO
FDA APPROVED			
EU REGULATIONS			

INDUSTRIES



ENGINEERED & SPECIALTY BELTS

Please contact Megadyne or your local partner distributor to obtain more information about our materials, processes, minimum quantities and delivery times.

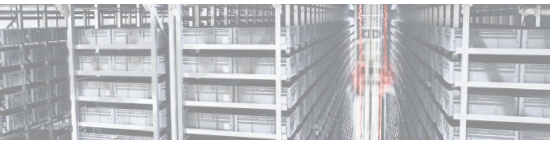

COVERS: POLYURETHANE

RED GRIP

ORANGE COVER

Z-COVER

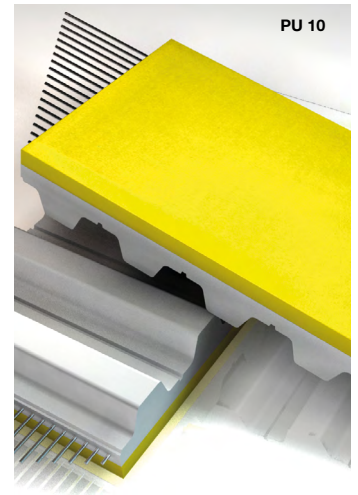

SOURCE LOCATION	ITALY	USA	ITALY, USA
COLOURS	●	●	● ●
RAW MATERIAL	PU/SYNTHETIC RUBBER	PU	PU
HARDNESS (SHA)	63 +/-4	42	56
COVER AND BELT COHESION METHOD	CO-EXTRUSION	CO-EXTRUSION	CO-EXTRUSION
STANDARD COVER THICKNESS RANGE (mm)	1 to 8	3/6/9	3/6
TOLERANCE COVER THICKNESS (mm)	+/- 0.3	+/- 0.3	+/- 0.3
WORKING TEMPERATURE (°C)	-20 /+60	-25 /+65	-25 /+70
COEFFICIENT OF FRICTION* (CoF)	0.70	0.80	0.60
MIN. PULLEY DIAMETER	x 30	x 20	x 25
WATER RESISTANCE	●●●○	●●●○	●●●○
ABRASION RESISTANCE	●●●●	●●●○	●●●○
OIL RESISTANCE**	●●●●	●●●○	●●●○
FEATURES/BENEFITS	Seamless alternative to Natural Rubber. Only available on MEGAFLEX.	Cover offering high-grip, good wear, and oil resistance. Available on MEGAFLEX only.	High-density, high CoF PU foam with good resistance to oil, and abrasion.
FOOD CONTACT APPROVED	NO	NO	NO
FDA APPROVED			
EU REGULATIONS			

INDUSTRIES 







COVERS: POLYURETHANE

GREEN MILLABLE URETHANE 40, 50, 60, 70, 85

BLACK MILLABLE URETHANE

POLYTHAN D44

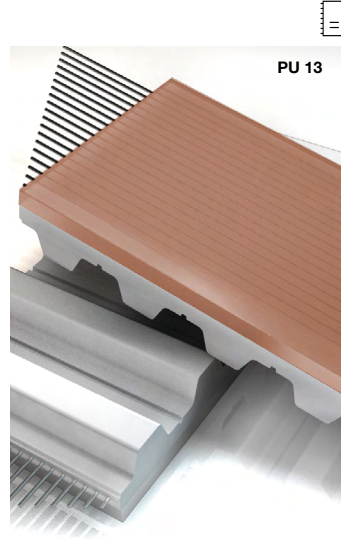
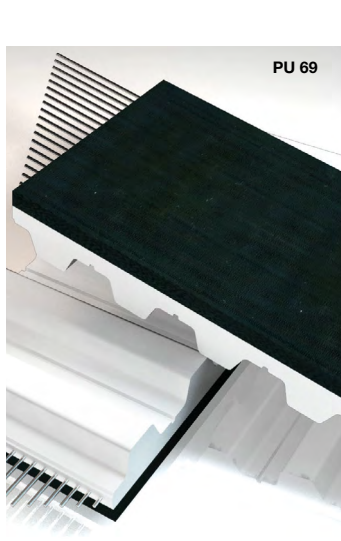
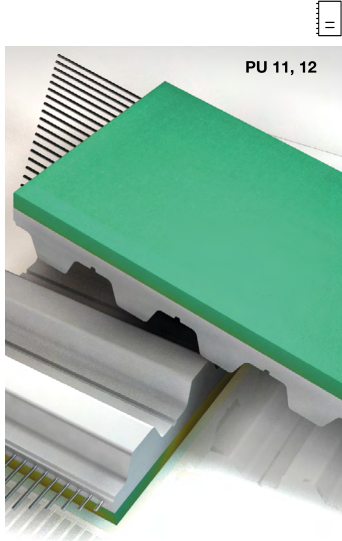

SOURCE LOCATION	USA					USA	USA
COLOURS	●					●	○
RAW MATERIAL	MILLABLE URETHANE					MILLABLE URETHANE	PU
HARDNESS (Sha)	40	50	60	70	85	80	72
COVER AND BELT COHESION METHOD	MOLDING					MOLDING	LAMINATION
STANDARD COVER THICKNESS RANGE (mm)	2.4 to 14					2.4 to 14	1 to 6
TOLERANCE COVER THICKNESS (mm)	+/- 0.3					+/- 0.3	+/- 0.5
WORKING TEMPERATURE (°C)	-20 /+80					-20 /+80	-10 /+60
COEFFICIENT OF FRICTION* (CoF)	0.60		0.55			0.55	0.70
MIN. PULLEY DIAMETER	x 30	x 35		x 40		x 40	x 30
WATER RESISTANCE	●●●○					●●●●	●●●○
ABRASION RESISTANCE	●●●●					●●●●	●●●○
OIL RESISTANCE**	●●●○					●●●○	●●●○
FEATURES/BENEFITS	Very good abrasion resistance with a high CoF. Commonly used in the Cable and Wire Industry.					Very good abrasion and tear-resistance. Formulated with ingredients considered FDA safe.	Good resistance against Ozone and UV radiation. Cut resistance makes it a good option to convey sheets and panels of wood and glass.
FOOD CONTACT APPROVED	NO					YES	NO
FDA APPROVED						YES	
EU REGULATIONS							

INDUSTRIES



ENGINEERED & SPECIALTY BELTS

Please contact Megadyne or your local partner distributor to obtain more information about our materials, processes, minimum quantities and delivery times.



COVERS: POLYURETHANE

CELLOFLEX

PU-YELLOW

PU - GREY/RED

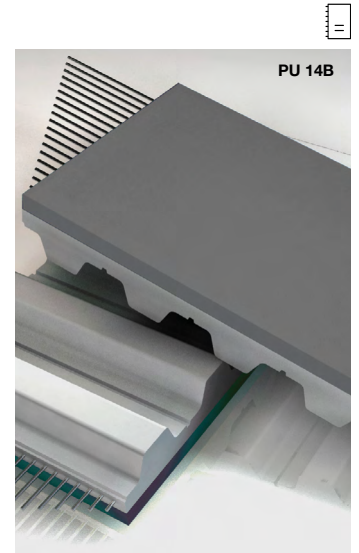
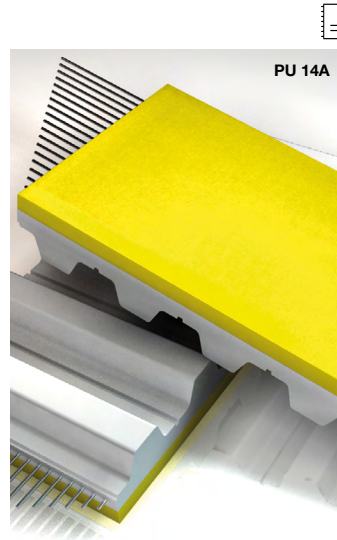
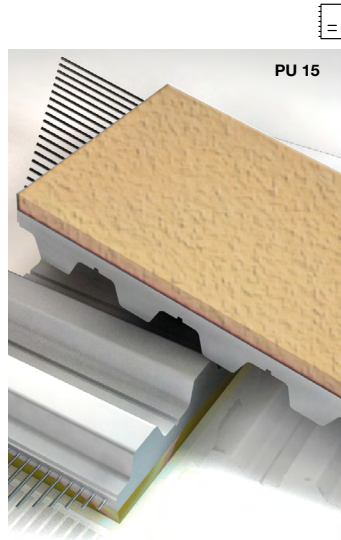

SOURCE LOCATION	ITALY, USA	ITALY	ITALY
COLOURS			
RAW MATERIAL	MICRO-CELLULAR PU	TWO COMPONENT PU FOAM	TWO COMPONENT PU FOAM
HARDNESS (Sha)	350 kg/m ³	SOFT: 35-40, STD: 50, HARD: 60-70	SOFT: 35-40, STD: 50, HARD: 60-70
COVER AND BELT COHESION METHOD	LAMINATION	SEAMLESS SPRAYING - LAMINATION	SEAMLESS SPRAYING
STANDARD COVER THICKNESS RANGE (mm)	2 to 5	1 to 10	1 to 10
TOLERANCE COVER THICKNESS (mm)	+/- 0.5	+/- 0.3	+/- 0.3
WORKING TEMPERATURE (°C)	-30 /+80	-10 /+60	-10 /+60
COEFFICIENT OF FRICTION* (CoF)	0.30	0.40	0.40
MIN. PULLEY DIAMETER	x 20	x 25	x 25
WATER RESISTANCE	● ○ ○ ○	● ● ○ ○	● ● ○ ○
ABRASION RESISTANCE	● ● ○ ○	● ● ● ●	● ● ● ●
OIL RESISTANCE**	● ○ ○ ○	● ● ● ○	● ● ● ○
FEATURES/BENEFITS	Highly flexible, good shock absorption. Use to move sensitive and fragile products. Better resistance than sylomer foams.	Very good abrasion resistance and high-grip against paper. Good machineability for vacuum holes and other modifications.	Very good abrasion resistance and high-grip against paper. Good machineability for vacuum holes and other modifications.
FOOD CONTACT APPROVED	NO	NO	NO
FDA APPROVED			
EU REGULATIONS			

INDUSTRIES

ENGINEERED & SPECIALTY BELTS



COVERS: POLYURETHANE

SYLOMER YELLOW

SYLOMER BLUE

SYLOMER GREEN

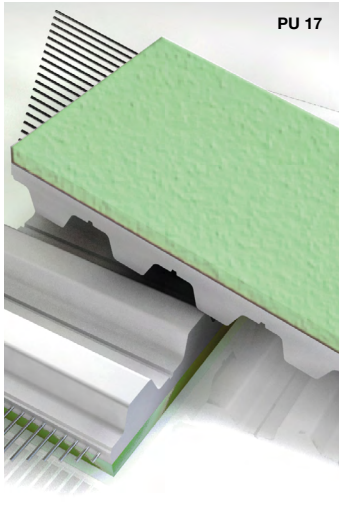
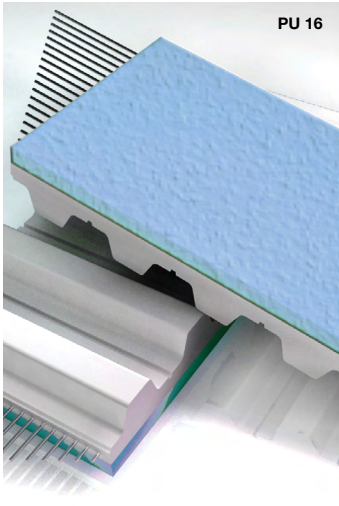
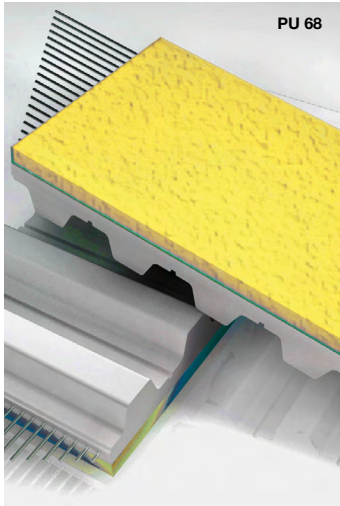

SOURCE LOCATION	ITALY, USA	ITALY, USA	ITALY, USA
COLOURS	●	●	●
RAW MATERIAL	PU Foam	PU Foam	PU Foam
HARDNESS (ShA)	150 kg/m ³	220 kg/m ³	300 kg/m ³
COVER AND BELT COHESION METHOD	LAMINATION	LAMINATION	LAMINATION
STANDARD COVER THICKNESS RANGE (mm)	1 to 12	2 to 20	2 to 20
TOLERANCE COVER THICKNESS (mm)	+/- 0.25	+/- 0.5	+/- 0.5
WORKING TEMPERATURE (°C)	-30 /+70	-30 /+70	-30 /+70
COEFFICIENT OF FRICTION* (CoF)	0.50	0.50	0.50
MIN. PULLEY DIAMETER	Ø min. +TKx5(****)	x 15	x 15
WATER RESISTANCE	●●●○	●●●○	●●●○
ABRASION RESISTANCE	●○○○	●○○○	●○○○
OIL RESISTANCE**	●○○○	●○○○	●○○○
FEATURES/BENEFITS	High-dynamic load capacity for movement of light and sensitive parts.	10 ShA offers high dynamic load capacity for handling of lightweight, fragile items.	15 ShA offers high dynamic load capacity for top pressure belts.
FOOD CONTACT APPROVED	NO	NO	NO
FDA APPROVED			
EU REGULATIONS			

INDUSTRIES



ENGINEERED & SPECIALTY BELTS

Please contact Megadyne or your local partner distributor to obtain more information about our materials, processes, minimum quantities and delivery times.



COVERS: POLYURETHANE/PVC

SYLOMER BROWN

APL RED

APL SUPERGRIP

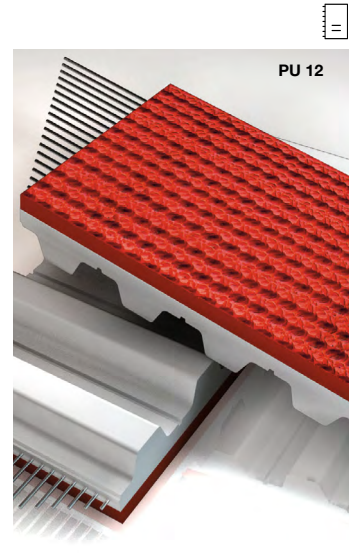
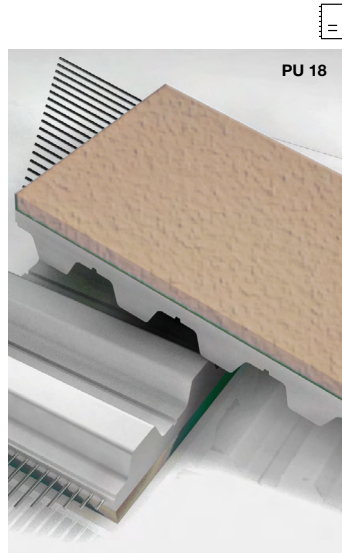

SOURCE LOCATION	ITALY, USA	ITALY	ITALY
COLOURS	●	●	●
RAW MATERIAL	PU Foam	PVC	PVC
HARDNESS (ShA)	400 kg/m ³	55	55
COVER AND BELT COHESION METHOD	LAMINATION	CO-EXTRUSION	CO-EXTRUSION
STANDARD COVER THICKNESS RANGE (mm)	1 to 12	3.5	5.2
TOLERANCE COVER THICKNESS (mm)	+/- 0.5	+/- 0.3	+/- 0.5
WORKING TEMPERATURE (°C)	-30 /+70	-20 /+60	-20 /+60
COEFFICIENT OF FRICTION* (CoF)	0.50	0.70	0.60
MIN. PULLEY DIAMETER	x 20	x 30	x 30
WATER RESISTANCE	●●●○	●●●○	●●●○
ABRASION RESISTANCE	●●○○	●●●○	●●●○
OIL RESISTANCE**	●○○○	●●●○	●●●○
FEATURES/BENEFITS	22 ShA, offers high dynamic load capacity for moving glass.	Seamless alternative to Natural Rubber. Blended elastomer offering high CoF, good oil resistance.	Cover offering high friction rough top surface, applicable for slight height compensation, low shock absorption capabilities. Improved adhesion even in case of moisture and dirt for use on lower angle incline product movement.
FOOD CONTACT APPROVED	NO	NO	NO
FDA APPROVED			
EU REGULATIONS			

INDUSTRIES

ENGINEERED & SPECIALTY BELTS



COVERS: PVC

PVC-FOIL BLUE

PVC-FOIL WHITE

SUPERGRIP PETROL

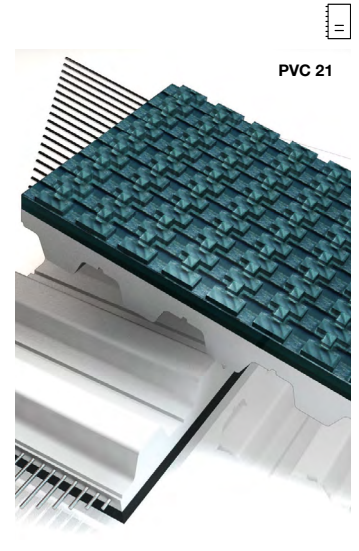

SOURCE LOCATION	ITALY, USA	ITALY, USA	ITALY, USA
COLOURS			
RAW MATERIAL	PVC	PVC	PVC
HARDNESS (ShA)	40	65	46
COVER AND BELT COHESION METHOD	LAMINATION	LAMINATION	CO-EXTRUSION - LAMINATION
STANDARD COVER THICKNESS RANGE (mm)	2	2	4.5
TOLERANCE COVER THICKNESS (mm)	+/- 0.5	+/- 0.5	+/- 0.5
WORKING TEMPERATURE (°C)	-15 /+70	-20 /+100	-10 /+60
COEFFICIENT OF FRICTION* (CoF)	0.90	0.80	0.90
MIN. PULLEY DIAMETER	40 mm	60 mm	60 mm
WATER RESISTANCE	●●●○	●●●○	●●●○
ABRASION RESISTANCE	●●○○	●●●○	●●○○
OIL RESISTANCE**	●●●○	●●●●	●●●○
FEATURES/BENEFITS	Good adhesion characteristics due to good CoF and smooth surface for the conveyance of paper and foils, wood and plastics. Seamless weldable on ML and MFX.	Good adhesion characteristics due to good CoF and smooth surface. Resistant to acids and oils. Formulated with ingredients considered FDA safe. Seamless weldable on ML and MFX.	Applicable for slight height compensation, low shock absorption capabilities. Improved adhesion even with moisture and dirt for incline, feed and take-away conveying applications. Seamless weldable on ML and MFX.
FOOD CONTACT APPROVED	NO	YES	NO
FDA APPROVED		YES	
EU REGULATIONS		YES	

INDUSTRIES			
-------------------	--	--	--

ENGINEERED & SPECIALTY BELTS

Please contact Megadyne or your local partner distributor to obtain more information about our materials, processes, minimum quantities and delivery times.

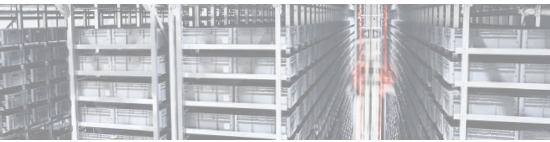

COVERS: PVC

SUPERGRIP WHITE

PVC-SAW-TOOTH

PVC-NAPPED



PVC 22



PVC 23



PVC 24

SOURCE LOCATION	ITALY, USA	ITALY, USA	ITALY, USA
COLOURS	●	●	●
RAW MATERIAL	PVC	PVC	PVC
HARDNESS (ShA)	60	60 +/-4	65
COVER AND BELT COHESION METHOD	LAMINATION	LAMINATION	LAMINATION
STANDARD COVER THICKNESS RANGE (mm)	3.0	2.5	1.5
TOLERANCE COVER THICKNESS (mm)	+/- 0.5	+/- 0.5	+/- 0.5
WORKING TEMPERATURE (°C)	-10 /+100	-15 /+70	-15 /+60
COEFFICIENT OF FRICTION* (CoF)	0.80	0.70	0.80
MIN. PULLEY DIAMETER	60 mm	60 mm	60 mm
WATER RESISTANCE	●●●○	●●●○	●●●○
ABRASION RESISTANCE	●●○○	●●○○	●●○○
OIL RESISTANCE**	●●●●	●●●●	●●●●
FEATURES/BENEFITS	Characteristics same as Supergrip petrol but less flexible. For the conveyance of food. Resistant against acids and bases.	FDA clear pattern for improved adhesion under wet conditions. Line contact, resistant against acids and bases.	Thin cover offers good CoF, even in wet conditions. Resistant to acids and oils. Formulated with FDA materials.
FOOD CONTACT APPROVED	YES	YES	YES
FDA APPROVED	YES	YES	YES
EU REGULATIONS	YES	YES	YES

INDUSTRIES			
-------------------	--	--	--

ENGINEERED & SPECIALTY BELTS



COVERS: PVC

PVC FISHBONE

MINIGRIP GREEN

STAGGERED SAWTOOTH

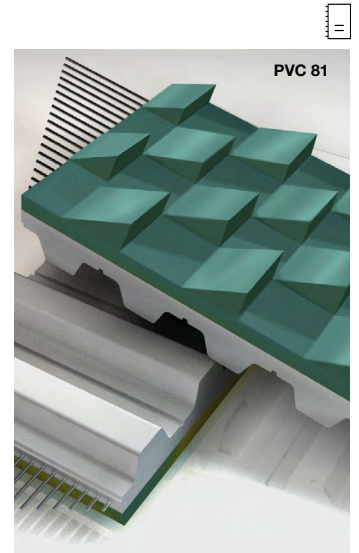
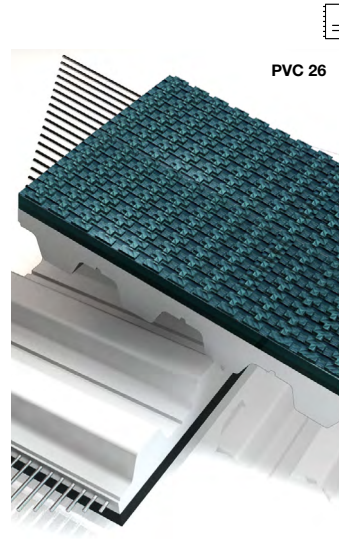

SOURCE LOCATION	ITALY	ITALY, USA	ITALY, USA
COLOURS	●	●	●
RAW MATERIAL	PVC	PVC	PVC
HARDNESS (ShA)	65	60	46
COVER AND BELT COHESION METHOD	LAMINATION	CO-EXTRUSION - LAMINATION	LAMINATION
STANDARD COVER THICKNESS RANGE (mm)	3	1.3	8
TOLERANCE COVER THICKNESS (mm)	+/- 0.5	+/- 0.5	+/- 0.5
WORKING TEMPERATURE (°C)	-15 /+90	-10 /+70	-20 /+70
COEFFICIENT OF FRICTION* (CoF)	0.60	0.70	0.90
MIN. PULLEY DIAMETER	x 30	30 mm	60 mm
WATER RESISTANCE	●●●○	●●●○	●●●○
ABRASION RESISTANCE	●●●○	●●○○	●●●○
OIL RESISTANCE**	●●●●	●●●○	●●●○
FEATURES/BENEFITS	Improved CoF in wet conditions. Narrow belts may only have a single diagonal-cut profile. Resistant to acids and oils. Formulated with FDA materials.	Thin cover structure with very good friction in wet or dusty conditions - reduces frictional stick. Resistant to acids and oils.	Very good CoF for gripping and incline conveying. Resistant to acids and oils.
FOOD CONTACT APPROVED	YES	NO	NO
FDA APPROVED	YES		
EU REGULATIONS	YES		

INDUSTRIES			
-------------------	--	--	--

ENGINEERED & SPECIALTY BELTS

Please contact Megadyne or your local partner distributor to obtain more information about our materials, processes, minimum quantities and delivery times.

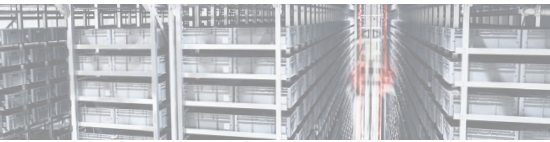

COVERS: NATURAL RUBBER

LINATEX™ RED

LINARD

LINAPLUS FG



SOURCE LOCATION	ITALY, USA	USA	ITALY, USA	ITALY, USA
COLOURS	●		●	●
RAW MATERIAL	NATURAL RUBBER		NATURAL RUBBER	NATURAL RUBBER
HARDNESS (ShA)	38	40	60	38
COVER AND BELT COHESION METHOD	LAMINATION	VULCANIZATION	LAMINATION	LAMINATION
STANDARD COVER THICKNESS RANGE (mm)	1 to 10	3 to 12, 7	1 to 6	1 to 3
TOLERANCE COVER THICKNESS (mm)	+/- 1 (***)		+/- 1 (***)	+/- 1 (***)
WORKING TEMPERATURE (°C)	-40 /+70		-30 /+70	-40 /+70
COEFFICIENT OF FRICTION* (CoF)	0.90		0.60	0.75
MIN. PULLEY DIAMETER	x 20		x 30	x 25
WATER RESISTANCE	●●●○		●●●○	●●●○
ABRASION RESISTANCE	●●●○		●●●○	●●○○
OIL RESISTANCE**	●○○○		●●○○	●○○○
FEATURES/BENEFITS	Cover offers high CoF, good wear resistance, good in wet conditions but poor in oil. Common used as discharge belts for use in vacuum VFFS.		Cover with high abrasion resistance but less adhesion in comparison to LINATEX™ (RU 27).	High CoF white non-marking natural rubber material. Formulated with FDA materials.
FOOD CONTACT APPROVED	NO		NO	YES
FDA APPROVED				YES
EU REGULATIONS				YES

INDUSTRIES



ENGINEERED & SPECIALTY BELTS



COVERS: NATURAL RUBBER

LINATRILE	RP 400 YELLOW	CORREX BEIGE
-----------	---------------	--------------

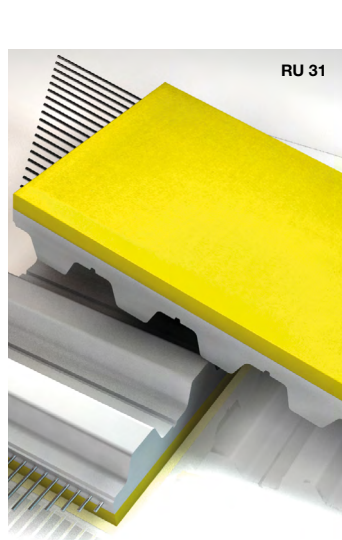
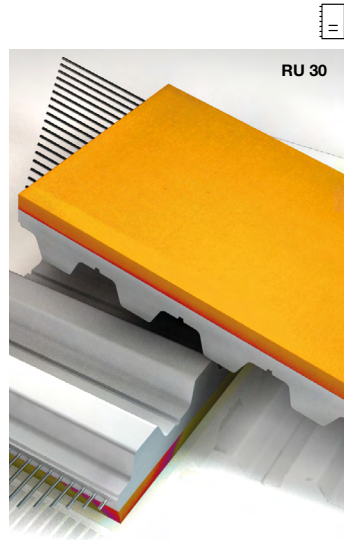

SOURCE LOCATION	ITALY, USA	ITALY	ITALY
COLOURS			
RAW MATERIAL	POLYMER NBR	CAOUTCHOUC (Natural Rubber)	NATURAL RUBBER
HARDNESS (ShA)	55	38	36
COVER AND BELT COHESION METHOD	LAMINATION	LAMINATION	LAMINATION
STANDARD COVER THICKNESS RANGE (mm)	1 to 10	2 to 6	2 to 6
TOLERANCE COVER THICKNESS (mm)	+/- 1(***)	+/- 0.5	+/- 0.5
WORKING TEMPERATURE (°C)	-20 /+110	-10 /+80	-10 /+70
COEFFICIENT OF FRICTION* (CoF)	0.70	0.80	0.70
MIN. PULLEY DIAMETER	x 25	x 20	x 20
WATER RESISTANCE	●●●○	●●●○	●●○○
ABRASION RESISTANCE	●●●○	●●●○	●●●○
OIL RESISTANCE**	●●●○	●○○○	●○○○
FEATURES/BENEFITS	Improved temperature, oil, grease and aging resistance compared to natural rubber. Good mechanical processing capability vacuum transport of oil-covered sheets.	Cover has fine fabric texture, characteristics similar to Natural Rubber but higher abrasion resistance.	Cover offers high CoF and high wear resistant features. Black contact layer.
FOOD CONTACT APPROVED	NO	NO	NO
FDA APPROVED			
EU REGULATIONS			

INDUSTRIES			
-------------------	--	--	--

ENGINEERED & SPECIALTY BELTS

Please contact Megadyne or your local partner distributor to obtain more information about our materials, processes, minimum quantities and delivery times.



COVERS: NATURAL RUBBER

CORREX BLACK

GUMMY CORREX AMBRA PARABLOND

TAN NATURAL RUBBER 40

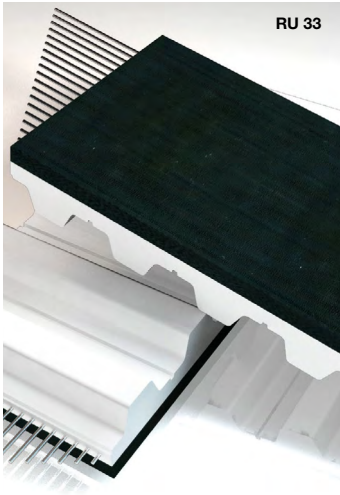

SOURCE LOCATION	ITALY	ITALY	USA
COLOURS	●	●	●
RAW MATERIAL	NATURAL RUBBER	NATURAL RUBBER	NATURAL RUBBER
HARDNESS (ShA)	60	48	40
COVER AND BELT COHESION METHOD	LAMINATION	VULCANIZATION	VULCANIZATION
STANDARD COVER THICKNESS RANGE (mm)	2 to 6	0.8 to 15	2.4 to 14
TOLERANCE COVER THICKNESS (mm)	+/- 0.5	+/- 0.3	+/- 0.3
WORKING TEMPERATURE (°C)	-10 /+70	-20 /+60	-20 /+80
COEFFICIENT OF FRICTION* (CoF)	0.60	0.60	0.60
MIN. PULLEY DIAMETER	x 30	x 30	x 20
WATER RESISTANCE	●●○○	●●●●	●●●○
ABRASION RESISTANCE	●●●○	●●●●	●●●○
OIL RESISTANCE**	●○○○	●○○○	●○○○
FEATURES/BENEFITS	Cover offers good abrasion resistance and lower friction than Correx Beige (RU 32).	Cover offers high CoF and higher abrasion resistance than other Natural Rubber compounds.	Cover offers non marking high CoF surface. Average wear and tear and abrasion resistance.
FOOD CONTACT APPROVED	NO	NO	NO
FDA APPROVED			
EU REGULATIONS			

INDUSTRIES



ENGINEERED & SPECIALTY BELTS



COVERS: NATURAL RUBBER

	BLUE ANTI GLAZE NATURAL RUBBER	DURATAQ™	RED NATURAL RUBBER 40
			
SOURCE LOCATION	USA	USA	USA
COLOURS			
RAW MATERIAL	NATURAL RUBBER	NATURAL RUBBER	NATURAL RUBBER
HARDNESS (ShA)	40	45	40
COVER AND BELT COHESION METHOD	VULCANIZATION	VULCANIZATION	VULCANIZATION
STANDARD COVER THICKNESS RANGE (mm)	2.4 to 14	2.4 to 14	2.4 to 14
TOLERANCE COVER THICKNESS (mm)	+/- 0.3	+/- 0.3	+/- 0.3
WORKING TEMPERATURE (°C)	-20 /+80	-20 /+100	-20 /+80
COEFFICIENT OF FRICTION* (CoF)	0.55	1.10	0.50
MIN. PULLEY DIAMETER	x 20	x 20	x 20
WATER RESISTANCE	●●●○	●●●○	●●●○
ABRASION RESISTANCE	●●●○	●●●●	●●○○
OIL RESISTANCE**	●○○○	●○○○	●○○○
FEATURES/BENEFITS	Cover offers a high CoF and good wear resistance. Anti glazing characteristic predestined for high speed paper feeder.	A premium Natural Rubber compound offering a custom blended proprietary rubber which has a high CoF and very good abrasion resistance.	Cover offering low durometer ShA and very good high friction.
FOOD CONTACT APPROVED	NO	NO	NO
FDA APPROVED			
EU REGULATIONS			
INDUSTRIES			

ENGINEERED & SPECIALTY BELTS

Please contact Megadyne or your local partner distributor to obtain more information about our materials, processes, minimum quantities and delivery times.



COVERS: NATURAL RUBBER

RED NATURAL RUBBER 60

BLUE NATURAL RUBBER 55

TENAX 40



SOURCE LOCATION	USA	USA	ITALY
COLOURS	●	●	●
RAW MATERIAL	NATURAL RUBBER	NATURAL RUBBER	NATURAL RUBBER
HARDNESS (ShA)	60	55	40
COVER AND BELT COHESION METHOD	VULCANIZATION	VULCANIZATION	VULCANIZATION
STANDARD COVER THICKNESS RANGE (mm)	2.4 to 14	2.4 to 14	0.8 to 15
TOLERANCE COVER THICKNESS (mm)	+/- 0.3	+/- 0.3	+/- 0.3
WORKING TEMPERATURE (°C)	-20 /+100	-20 /+80	-20 /+60
COEFFICIENT OF FRICTION* (CoF)	0.50	0.40	0.75
MIN. PULLEY DIAMETER	x 30	x 25	x 30
WATER RESISTANCE	●●●○	●●●○	●●●●
ABRASION RESISTANCE	●●●○	●●●○	●●●●
OIL RESISTANCE**	●○○○	●○○○	●○○○
FEATURES/BENEFITS	Covers offering good friction and good abrasion resistance. Higher abrasion resistance than Natural Rubber 40	Cover offering high CoF, good wear resistance, very good water resistance.	Cover is a seamless alternative to other Natural Rubber compounds. Slightly softer than Tenax Standard with higher grip.
FOOD CONTACT APPROVED	NO	NO	NO
FDA APPROVED			
EU REGULATIONS			

INDUSTRIES



ENGINEERED & SPECIALTY BELTS



COVERS: NATURAL RUBBER

TENAX STANDARD	HONEYCOMB	BLUE GRIP
----------------	-----------	-----------

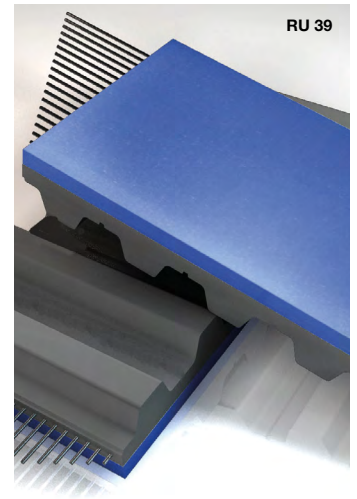
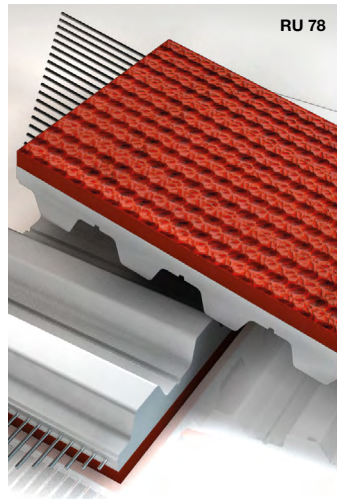

SOURCE LOCATION	ITALY	ITALY, USA	SPAIN
COLOURS	●	●	●
RAW MATERIAL	NATURAL RUBBER	NATURAL RUBBER	NR / BR
HARDNESS (ShA)	45	50	57
COVER AND BELT COHESION METHOD	VULCANIZATION	LAMINATION	ONE SHOT CURING
STANDARD COVER THICKNESS RANGE (mm)	0.8 to 15	4.5 to 15	<=12.5 (*)
TOLERANCE COVER THICKNESS (mm)	+/- 0.3	+/- 0.5	+/- 0.3
WORKING TEMPERATURE (°C)	-20 /+60	-20 /+60	-20 /+80
COEFFICIENT OF FRICTION* (CoF)	0.70	0.60	0.80
MIN. PULLEY DIAMETER	x 30	x 30	Ø min. +TKx5(***)
WATER RESISTANCE	●●●●	●●●●	●●○○
ABRASION RESISTANCE	●●●●	●●●●	●●●●
OIL RESISTANCE**	●○○○	●○○○	●●○○
FEATURES/BENEFITS	Cover is slightly harder than Tenax 40, but offers very good abrasion resistance.	Cover offering high-friction rough top surface, applicable for slight height compensation, low shock absorption capabilities. Improved adhesion even with moisture and dirt for use on lower angle incline product movement.	Very good wear resistance. Alternative to Natural Rubber. Only available on rubber base belts.
FOOD CONTACT APPROVED	NO	NO	NO
FDA APPROVED			
EU REGULATIONS			

INDUSTRIES			

ENGINEERED & SPECIALTY BELTS

Please contact Megadyne or your local partner distributor to obtain more information about our materials, processes, minimum quantities and delivery times.

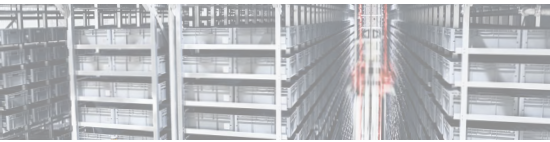

COVERS: NATURAL RUBBER

LOW DURO NR R34

YELLOW GUM R14

LOW DURO BLACK NEOPRENE R35

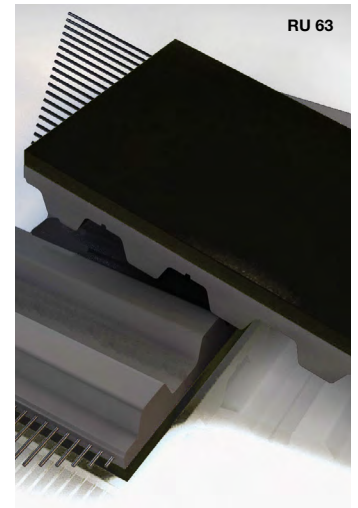
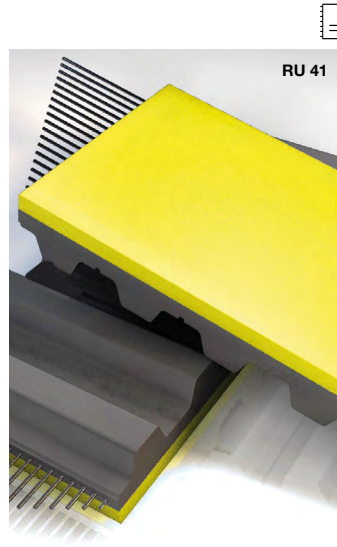
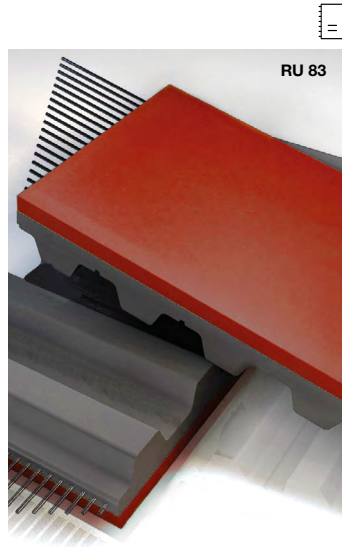

SOURCE LOCATION	SPAIN	SPAIN	SPAIN
COLOURS	●	●	●
RAW MATERIAL	NATURAL RUBBER	NATURAL RUBBER	NATURAL RUBBER
HARDNESS (Sha)	35-45	35-45	40-50
COVER AND BELT COHESION METHOD	TWO SHOT CURING	ONE SHOT CURING	ONE SHOT CURING
STANDARD COVER THICKNESS RANGE (mm)	1.0 to 13	1.6 to 12	1.0 to 13
TOLERANCE COVER THICKNESS (mm)	+/- 0.3	+/- 0.3	+/- 0.3
WORKING TEMPERATURE (°C)	-25 /+80	-25 /+80	-20 /+85
COEFFICIENT OF FRICTION* (CoF)	0.70	0.80	0.55
MIN. PULLEY DIAMETER	Ø min. +TKx5(****)	Ø min. +TKx5(****)	Ø min. +TKx5(****)
WATER RESISTANCE	●●●○	●●●○	●●●○
ABRASION RESISTANCE	●●●●	●●●●	●●○○
OIL RESISTANCE**	●○○○	●○○○	●●●○
FEATURES/BENEFITS	Non marking compound for applications requiring, high coefficient of friction. Excellent abrasion resistance. Very good tear resistance. Low hysteresis. Only available on rubber base belts.	Cover offers high CoF, very good wear resistance. Compound common used in indexing, corrugating, positioning and packaging applications. Only available on rubber base belts.	Cover offering high-friction, non-marking feature. Only available on rubber base belts.
FOOD CONTACT APPROVED	NO	NO	NO
FDA APPROVED			
EU REGULATIONS			

INDUSTRIES

ENGINEERED & SPECIALTY BELTS



COVERS: NATURAL RUBBER

ORANGE NATURAL RUBBER R66

POROL BLACK

NBR

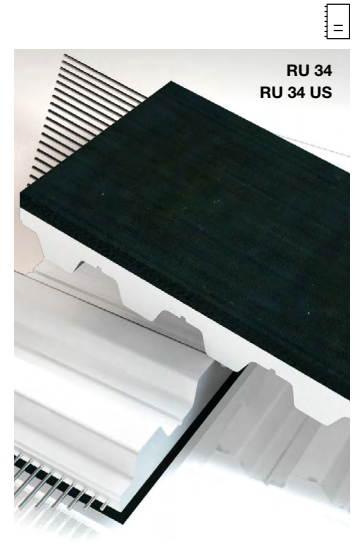
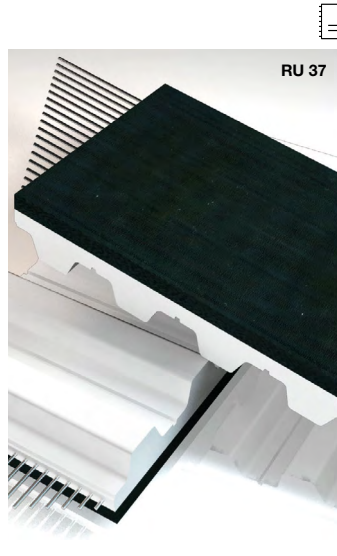
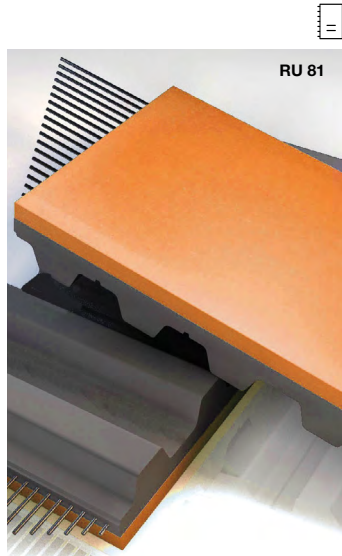

SOURCE LOCATION	SPAIN	ITALY, USA	ITALY, USA	USA
COLOURS				
RAW MATERIAL	NATURAL RUBBER	NATURAL CELLULAR RUBBER FOAM	NITRILE CAOUTCHOUC	
HARDNESS (ShA)	42-48	290 kg/m ³	50	65 70
COVER AND BELT COHESION METHOD	TWO SHOT CURING	LAMINATION	LAMINATION	VULCANIZATION
STANDARD COVER THICKNESS RANGE (mm)	1.0 to 13	2 to 20	2 to 6	0.8 to 15
TOLERANCE COVER THICKNESS (mm)	+/- 0.3	+/- 0.5	+/- 0.5	+/- 0.3
WORKING TEMPERATURE (°C)	-30 /+80	-40 /+70	-35 /+70	0 /+120
COEFFICIENT OF FRICTION* (CoF)	0.72	1.2	0.70	0.60
MIN. PULLEY DIAMETER	Ø min. +TKx5(****)	x 15	x 30	x 35
WATER RESISTANCE	●●●○	●●●●	●●●●	●●●○
ABRASION RESISTANCE	●●●○	●●○○	●○○○	●●●○
OIL RESISTANCE**	●○○○	●●○○	●●●○	●●●○
FEATURES/BENEFITS	Cover is an alternative to DURATAQ™ offering a custom blended proprietary rubber which has a high CoF, and very good abrasion resistance. Only available on rubber base belts.	Cover is closed cell, soft elastic cellular rubber with good wear resistance. On request with Nylon cover for bottle descrambling.	Cover offers improved oil and grease resistance compared to natural rubber.	
FOOD CONTACT APPROVED	NO	NO	NO	
FDA APPROVED				
EU REGULATIONS				

INDUSTRIES			
-------------------	--	--	--

ENGINEERED & SPECIALTY BELTS

Please contact Megadyne or your local partner distributor to obtain more information about our materials, processes, minimum quantities and delivery times.



COVERS: NITRILE-NEOPRENE

WHITE NITRILE

GREEN NITRILE 55



SOURCE LOCATION	USA	USA
COLOURS	●	●
RAW MATERIAL	CARBOXILATED NITRILE	NITRILE
HARDNESS (Sha)	40	55
COVER AND BELT COHESION METHOD	VULCANIZATION	VULCANIZATION
STANDARD COVER THICKNESS RANGE (mm)	2.4 to 14	2.4 to 14
TOLERANCE COVER THICKNESS (mm)	+/- 0.3	+/- 0.3
WORKING TEMPERATURE (°C)	-20 /+120	-20 /+120
COEFFICIENT OF FRICTION* (CoF)	0.70	0.70
MIN. PULLEY DIAMETER	x 25	x 30
WATER RESISTANCE	●●●○	●●●○
ABRASION RESISTANCE	●●●○	●●●●
OIL RESISTANCE**	●●●●	●●●●
FEATURES/BENEFITS	Cover offering the benefit high-friction and good wear resistance. Very good oil resistance by moderate temperature up to +120° C offers a wide range of applications.	Cover offering high CoF and moderate abrasion / water / oil resistance in ambient temperatures.
FOOD CONTACT APPROVED	YES	NO
FDA APPROVED	YES	
EU REGULATIONS	YES	

INDUSTRIES



ENGINEERED &
SPECIALTY BELTS



COVERS: NITRILE-NEOPRENE

BLACK NEOPRENE

TAN NEOPRENE 55

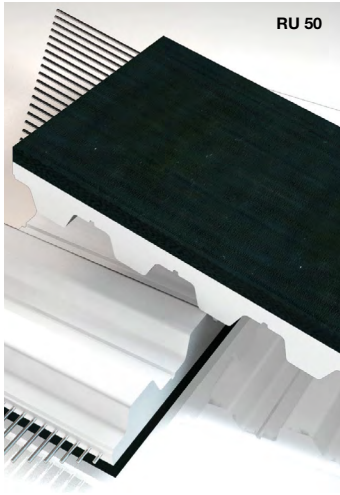

SOURCE LOCATION	ITALY, USA		USA
COLOURS	●		●
RAW MATERIAL	NEOPRENE		NEOPRENE
HARDNESS (ShA)	50	70	55
COVER AND BELT COHESION METHOD	LAMINATION	VULCANIZATION	VULCANIZATION
STANDARD COVER THICKNESS RANGE (mm)	3 to 12	0.8 to 15	2.4 to 14
TOLERANCE COVER THICKNESS (mm)	+/- 0.3		+/- 0.3
WORKING TEMPERATURE (°C)	-20 /+60	-10 /+100	-20 /+120
COEFFICIENT OF FRICTION* (CoF)	0.60		1.60
MIN. PULLEY DIAMETER	x 30		x 30
WATER RESISTANCE	●●●○		●●●○
ABRASION RESISTANCE	●●●○		●●●○
OIL RESISTANCE**	●●●○		●●●○
FEATURES/BENEFITS	Cover offers high CoF and moderate abrasion/water/oil resistance in ambient temperatures.		Cover offers high CoF and good wear resistance.
FOOD CONTACT APPROVED	NO		YES
FDA APPROVED			YES
EU REGULATIONS			

INDUSTRIES



ENGINEERED & SPECIALTY BELTS

Please contact Megadyne or your local partner distributor to obtain more information about our materials, processes, minimum quantities and delivery times.

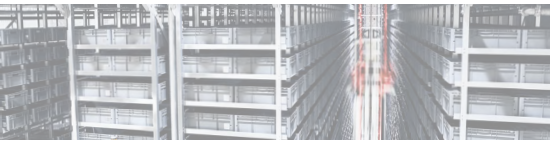

COVERS: POLYCHLOROPRENE

BLUE FDA NEOPRENE 65

YELLOW NEOPRENE R15

HIGH DURO NEOPRENE R18

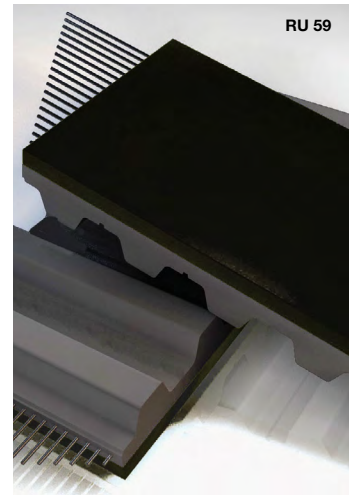

SOURCE LOCATION	SPAIN	SPAIN	SPAIN
COLOURS			
RAW MATERIAL	POLYCHLOROPRENE	POLYCHLOROPRENE	POLYCHLOROPRENE
HARDNESS (ShA)	63-73	35-45	70-80
COVER AND BELT COHESION METHOD	ONE SHOT CURING	ONE SHOT CURING	ONE SHOT CURING
STANDARD COVER THICKNESS RANGE (mm)	1.6 to 12	1.0 to 13	1.0 to 13
TOLERANCE COVER THICKNESS (mm)	+/- 0.3	+/- 0.3	+/- 0.3
WORKING TEMPERATURE (°C)	-35 /+105	-25 /+80	-20 /+80
COEFFICIENT OF FRICTION* (CoF)	0.80	0.65	0.60
MIN. PULLEY DIAMETER	Ø min. +TKx5(****)	Ø min. +TKx5(****)	Ø min. +TKx5(****)
WATER RESISTANCE	●●●○	●●●○	●●●○
ABRASION RESISTANCE	●●●●	●●●○	●●●○
OIL RESISTANCE**	●●●○	●●●○	●●●○
FEATURES/BENEFITS	Cover offers good resistance to weather and ozone environments. Self extinguishing. Good resistance to acid solutions. Formulated with FDA materials. Only available on rubber base belts.	Cover offers a Neoprene alternative for applications requiring better resistance to heat, oils, greases, solvents. Only available on rubber base belts.	Cover offering a high ShA, black non-marking neoprene compound. Only available on rubber base belts.
FOOD CONTACT APPROVED	YES	NO	NO
FDA APPROVED	YES		
EU REGULATIONS			

INDUSTRIES

ENGINEERED & SPECIALTY BELTS

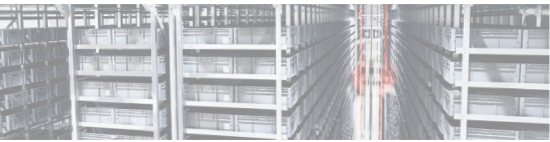

COVERS: POLYCHLOROPRENE

50 DURO GRAY NEOPRENE R23

65 DURO GRAY NEOPRENE R24

HIGH DURO PINK NEOPRENE R25



SOURCE LOCATION	SPAIN	SPAIN	SPAIN
COLOURS	●	●	●
RAW MATERIAL	POLYCHLOROPRENE	POLYCHLOROPRENE	POLYCHLOROPRENE
HARDNESS (ShA)	50-60	60-70	65-75
COVER AND BELT COHESION METHOD	ONE SHOT CURING	ONE SHOT CURING	ONE SHOT CURING
STANDARD COVER THICKNESS RANGE (mm)	1.0 to 13	1.0 to 13	1.0 to 13
TOLERANCE COVER THICKNESS (mm)	+/- 0.3	+/- 0.3	+/- 0.3
WORKING TEMPERATURE (°C)	-25 /+80	-25 /+80	-20 /+90
COEFFICIENT OF FRICTION* (CoF)	0.65	0.65	0.60
MIN. PULLEY DIAMETER	Ø min. +TKx5(****)	Ø min. +TKx5(****)	Ø min. +TKx5(****)
WATER RESISTANCE	●●●○	●●●○	●●●○
ABRASION RESISTANCE	●●●○	●●●○	●●●○
OIL RESISTANCE**	●●●○	●●●○	●●●○
FEATURES/BENEFITS	Cover offering a medium ShA, non-marking compound, good heat resistance, CoF properties and colour stability. Only available on rubber base belts.	Cover offering medium ShA, non-marking compound. Formulated with FDA materials. Only available on rubber base belts.	Cover offering non-marking compound. Good friction properties and heat-resistance. Only available on rubber base belts.
FOOD CONTACT APPROVED	NO	YES	NO
FDA APPROVED		YES	
EU REGULATIONS			

INDUSTRIES			
-------------------	--	--	--

ENGINEERED & SPECIALTY BELTS

Please contact Megadyne or your local partner distributor to obtain more information about our materials, processes, minimum quantities and delivery times.



COVERS: POLYCHLOROPRENE

STATIC DISSIPATING NEOPRENE ISEPO

LOW DURO WHITE NEOPRENE R92

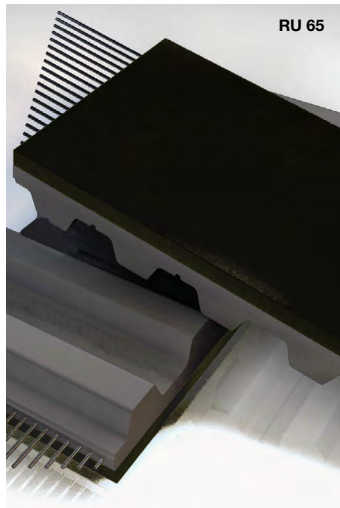

SOURCE LOCATION	SPAIN	SPAIN
COLOURS	●	●
RAW MATERIAL	POLYCHLOROPRENE	POLYCHLOROPRENE
HARDNESS (ShA)	67-77	35-45
COVER AND BELT COHESION METHOD	ONE SHOT CURING	ONE SHOT CURING
STANDARD COVER THICKNESS RANGE (mm)	1.0 to 13	1.0 to 10
TOLERANCE COVER THICKNESS (mm)	+/- 0.3	+/- 0.3
WORKING TEMPERATURE (°C)	-20 /+80	-20 /+90
COEFFICIENT OF FRICTION* (CoF)	0.60	0.65
MIN. PULLEY DIAMETER	Ø min. +TKx5(****)	Ø min. +TKx5(****)
WATER RESISTANCE	●●●○	●●●○
ABRASION RESISTANCE	●●●○	●●●○
OIL RESISTANCE**	●●●○	●●●○
FEATURES/BENEFITS	Cover used on belts requiring high conductivity. Compound exceed the ISO/ RMA classification for antistatic, static dissipating belts. Only available on rubber base belts.	Cover offers low ShA non-marking compound, offers high CoF and good wear resistance. Formulated with FDA materials. Only available on rubber base belts.
FOOD CONTACT APPROVED	NO	YES
FDA APPROVED		YES
EU REGULATIONS		

INDUSTRIES



COVERS: EPDM-VITON-HNBR

EPDM	VITON™ (KFM)	HTX (SILBLUE)
------	--------------	---------------

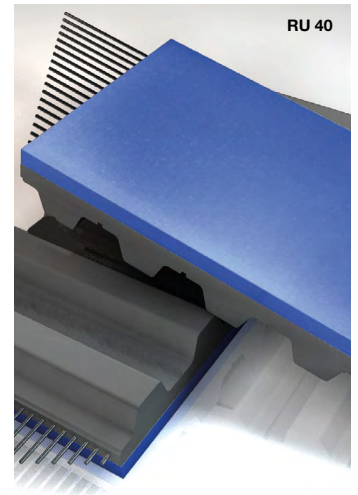
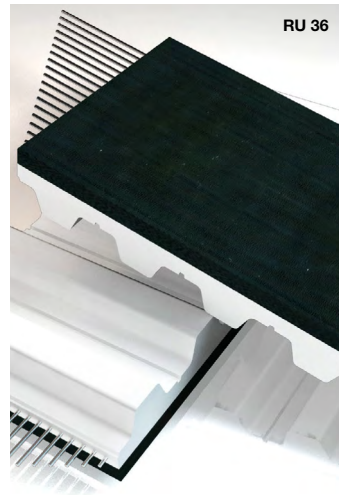
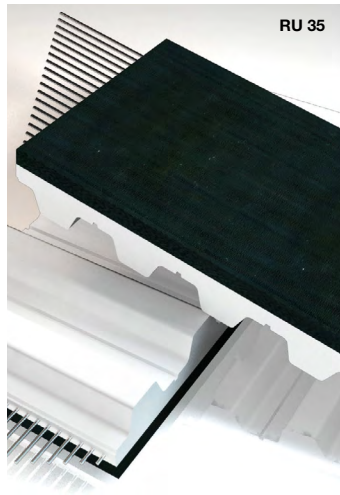

SOURCE LOCATION	ITALY	ITALY	SPAIN
COLOURS	●	●	●
RAW MATERIAL	ETHYLENE-PROPYLENE-DIENE-MONOMER	FLUOROPOLYMER	SILICONE
HARDNESS (ShA)	70	75	64
COVER AND BELT COHESION METHOD	LAMINATION	LAMINATION	ONE SHOT CURING
STANDARD COVER THICKNESS RANGE (mm)	2 to 5	2 to 4	<= 12(*)
TOLERANCE COVER THICKNESS (mm)	+/- 0.5	+/- 0.5	+/- 0.3
WORKING TEMPERATURE (°C)	-20 /+120	-10/+250	0 /+175
COEFFICIENT OF FRICTION* (CoF)	1.10	0.70	1.60
MIN. PULLEY DIAMETER	x 35	x 40	Ø min. +TKx5(***)
WATER RESISTANCE	●●●●	●●●●	●●●●
ABRASION RESISTANCE	●○○○	●●●○	●●○○
OIL RESISTANCE**	●○○○	●●●●	●●●○
FEATURES/BENEFITS	Cover offers high-temperature range, good chemical and aging resistance.	Cover offers extremely high-temperature and oil resistance. ATTENTION: For Lamination, attention must be given to the lower temperature resistance of base belt and adhesive used.	Cover offers high-temperature and UV resistance. Non-marking compound common used in printing applications. Only available on rubber base belts.
FOOD CONTACT APPROVED	NO	NO	NO
FDA APPROVED			
EU REGULATIONS			
INDUSTRIES			

ENGINEERED & SPECIALTY BELTS

Please contact Megadyne or your local partner distributor to obtain more information about our materials, processes, minimum quantities and delivery times.

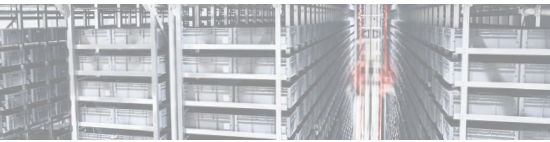

COVERS: EPDM-VITON-HNBR

70 DURO GREY HNBR - HTG

LEV-HT-4 (LEVAPREN®)

SPONGE RUBBER ORANGE

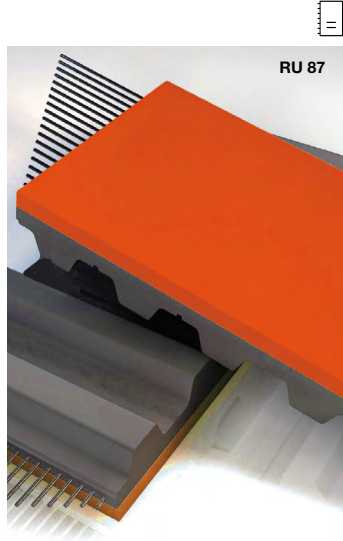

SOURCE LOCATION	SPAIN	SPAIN	ITALY
COLOURS	●	●	●
RAW MATERIAL	HNBR	EVA	NATURAL RUBBER
HARDNESS (Sha)	66-76	69-77	250 kg/m ³
COVER AND BELT COHESION METHOD	ONE SHOT CURING	ONE SHOT CURING	LAMINATION
STANDARD COVER THICKNESS RANGE (mm)	1/10	1.0 - 10.0	15 - 30
TOLERANCE COVER THICKNESS (mm)	+/- 0.3	+/- 0.3	+/- 0.5
WORKING TEMPERATURE (°C)	-30 /+150	-20 /+150	-40 /+60
COEFFICIENT OF FRICTION* (CoF)	0.55	0.62	ON REQUEST
MIN. PULLEY DIAMETER	Ø min. +TKx5(****)	Ø min. +TKx5(****)	ON REQUEST
WATER RESISTANCE	●●●○	●●●○	●●○○
ABRASION RESISTANCE	●●●○	●●●○	●○○○
OIL RESISTANCE**	●●●●	●●●●	●●○○
FEATURES/BENEFITS	Cover offers higher temperature applications where UV resistance is needed. Only available for 8M, H and T10 belt profiles. Only available on rubber base belts.	Cover offers higher temperature applications than HNBR and even better oil resistance.	Hi grip rubber sponge for sensitive products.
FOOD CONTACT APPROVED	NO	YES	NO
FDA APPROVED			
EU REGULATIONS			

INDUSTRIES



ENGINEERED & SPECIALTY BELTS



COVERS: OTHER

NFB/NFT

TT60

CHROME LEATHER

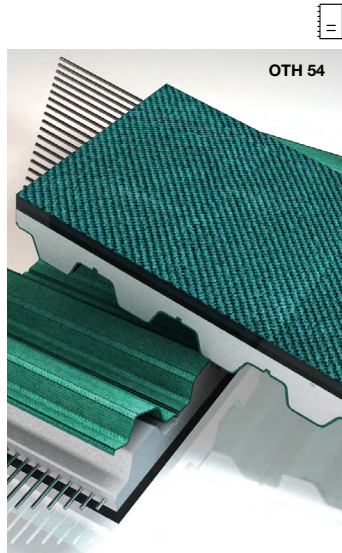

SOURCE LOCATION	ITALY, USA	ITALY	ITALY, USA
COLOURS	● ● (antistatic)	● ●	●
RAW MATERIAL	NYLON FABRIC	FELT	LEATHER
HARDNESS (Sha)	—	55	65
COVER AND BELT COHESION METHOD	CO-EXTRUSION - LAMINATION	LAMINATION	LAMINATION
STANDARD COVER THICKNESS RANGE (mm)	0.15 - 0.6	2	2 to 3
TOLERANCE COVER THICKNESS (mm)	—	+/- 1.0	+/- 0.5
WORKING TEMPERATURE (°C)	-20 /+80	-10 /+120	0 /+60
COEFFICIENT OF FRICTION* (CoF)	0.25	0.40	0.40
MIN. PULLEY DIAMETER	According to the belt FEATURES	120 mm	x 50
WATER RESISTANCE	●●●○	●○○○	●●●○
ABRASION RESISTANCE	●●○○	●●●●	●●●○
OIL RESISTANCE**	●●○○	●●○○	●●●○
FEATURES/BENEFITS	NFT/NFB offers low friction for accumulation as well as low-noise benefits and is usually applied Co-extrusion on base belts. In this case the min. pulley diameters indicated for each belt type and pitch are valid. Antistatic version available.	Antistatic cover provides a soft, non-marking, and good oil resistance surface for moving sharp, oily surface parts. Works well downline in complement to Kevlar® for higher temperature conveying.	Cover has a roughened surface that offers very good oil / grease resistance and good cut resistance for moving sharp oily parts.
FOOD CONTACT APPROVED	NO	NO	NO
FDA APPROVED			
EU REGULATIONS			

INDUSTRIES



ENGINEERED &
SPECIALTY BELTS

Please contact Megadyne or your local partner distributor to obtain more information about our materials, processes, minimum quantities and delivery times.



COVERS: OTHER

KEVLAR® FELT

FAG 25 GREEN FELT

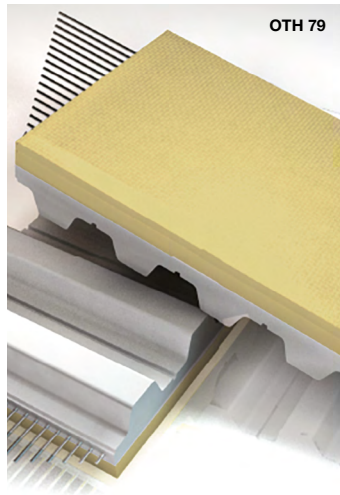

OTH 79

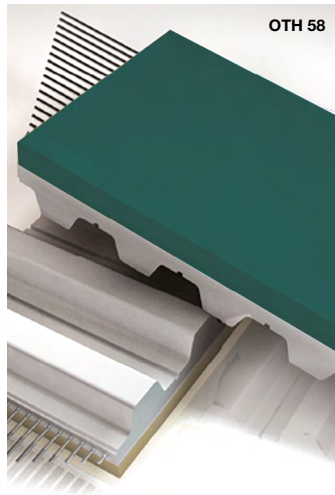

OTH 58

SOURCE LOCATION	ITALY, USA	ITALY
COLOURS	●	●
RAW MATERIAL	ARAMID	POLYESTERFELT
HARDNESS (Sha)	—	70
COVER AND BELT COHESION METHOD	LAMINATION	LAMINATION
STANDARD COVER THICKNESS RANGE (mm)	6/8	5
TOLERANCE COVER THICKNESS (mm)	+/- 1.0	+/- 1
WORKING TEMPERATURE (°C)	-20 /+450	-20 /+120
COEFFICIENT OF FRICTION* (CoF)	Values upon request	VALUE ON REQUEST
MIN. PULLEY DIAMETER	—	120 MM
WATER RESISTANCE	● ○ ○ ○	● ○ ○ ○
ABRASION RESISTANCE	● ● ● ○	● ● ● ●
OIL RESISTANCE**	● ○ ○ ○	● ● ○ ○
FEATURES/BENEFITS	Excellent heat-resistance for high temperature applications such as aluminum extrusion	The felt provides a soft, non-marking, and good oil resistance surface for moving sharp, oily surface parts. Works well downline in complement to Kevlar® for higher temperature conveying.
FOOD CONTACT APPROVED	NO	NO
FDA APPROVED		
EU REGULATIONS		

INDUSTRIES



SILICONE RANGE

SILICONE COATED FABRIC WITH HOLES AND SLOTS

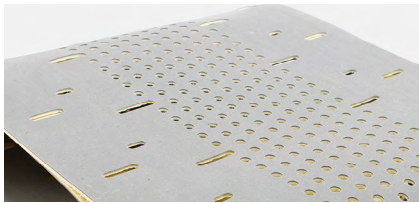

SILICONE COATED FOAM ON MEGAPOWER SUBSTRATE

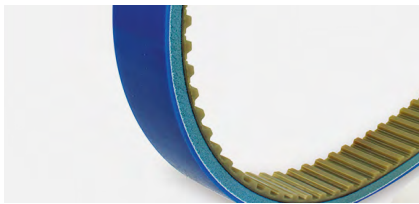

SILICONE COATED TIMING BELT

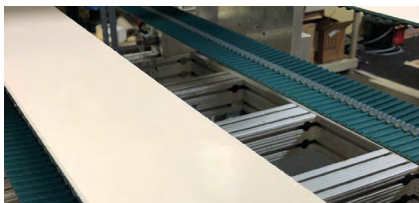

Megadyne has developed state of the art processes for applying silicone to synchronous and non-synchronous belts and fabrics. Ongoing investments in automation with a strategic focus on process controls and high-quality repeatability have been made. Through continuous material feed, increased speeds, line efficiency, and operator engagement with screen panel controls, we are able to maintain extremely tight manufacturing tolerances and high-quality standards.

Coated belts are commonly used in product handling applications where environmental or special handling features are needed. Additionally, a thin coating on certain substrates allow for the finished product to offer good flexibility, enabling the belt to be used on low profile conveyors where designs such as knife-edge pulleys are common.

FDA Silicone allows the use of our product in applications such as hygienic goods and medical related parts and components. Silicone is an excellent cover material where the use of glues and adhesives are present in product manufacturing and require easy release and clean up. Silicone also has excellent heat-resistance, making it an ideal solution for applications in high heat environments.

Silicone cover can be applied on different substrates, as a rubber timing belts, moulded or open-ended polyurethane timing belts, truly endless flex TPU belts, rubber and polyurethane Multi-rib V-Belts, rubber banded V-Belts, rubber Flat Belts. Silicone coated products can be further customised with modifications such as holes and slots to meet application needs such as vacuum draw.

	SILICONE TRANSPARENT COVER	SILICONE BLUE 24 COVER	SILICONE CRYSTAL 25 COVER	SILICONE RED HT 30 COVER	SILICONE 35 COVER	SILICONE WR 43 COVER
SOURCE LOCATION	ITALY	ITALY	ITALY	ITALY	ITALY - USA	ITALY
COLOUR	○	●	○	●	● ● ● ● ●	● ●
RAW MATERIAL	SILICONE	SILICONE	SILICONE	SILICONE	SILICONE	SILICONE
HARDNESS (ShA)	20	24	25	30	35	43
COVER AND BELT COHESION METHOD	knife coating	knife coating	knife coating	knife coating	knife coating	knife coating
STANDARD COVER THICKNESS RANGE (mm)	1 to 10	1 to 10	1 to 10	1 to 10	1 to 10	1 to 10
TOLERANCE COVER THICKNESS (mm)	+/- 0.3	+/- 0.3	+/- 0.3	+/- 0.3	+/- 0.3	+/- 0.3
WORKING TEMPERATURE (°C)	-40 /+180	-40 /+180	-60 /+180	-60 /+180 up to +300 for short time period*	-60 /+180	-60 /+180
MIN. PULLEY DIAMETER	x 20	x 20	x 20	x 20	x 20	x 20
WATER RESISTANCE	●●●○	●●●○	●●●○	●●●○	●●●○	●●●○
ABRASION RESISTANCE	●○○○	●○○○	●○○○	●●○○	●○○○	●●○○
OIL RESISTANCE**	●●○○	●●○○	●●○○	●●●○	●●●○	●●●○
FEATURES/BENEFITS	Cover offers high-temperature resistance, excellent grip and ease of product release, making clean-up of materials like adhesives easy.					
FC APPROVED	no	yes	yes	no	yes	yes
FDA APPROVED	no	yes	yes	no	yes	yes
EU REGULATIONS	no	no	no	no	no	no
INDUSTRIES						

ENGINEERED & SPECIALTY BELTS

Please contact Megadyne or your local partner distributor to obtain more information about our materials, processes, minimum quantities and delivery times.



PRODUCT EXAMPLE GALLERY



ENGINEERED &
SPECIALTY BELTS

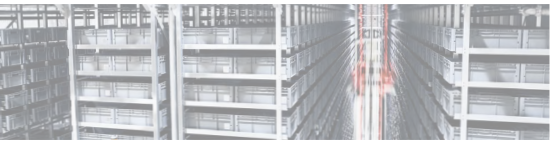

COVERS: BELT WORKSHEET

Choosing the right belt cover for a new application, requires a thorough understanding of the belt requirement and the environment in which the belt will operate. Reviewing the questions below will help guide you through the process.
If desired, please copy this page, scan and send to your sales contact.

Belt Finish			
Width:	Pitch:	Lenght:	Quantity:
Belt Type			
<input type="checkbox"/> ML Joined Endless	<input type="checkbox"/> PPJ - Pin Joint	<input type="checkbox"/> ML Open-Ended	<input type="checkbox"/> ML Belt Clamp Used
<input type="checkbox"/> MFX Flex Type	<input type="checkbox"/> MP Molded Endless	<input type="checkbox"/> Neoprene Endless Molded	
<input type="checkbox"/> Others			
Application			
Is the product to be moved on a horizontal, vertical or inclined plane?			
<input type="checkbox"/> Conveyor	<input type="checkbox"/> VFFS or FFS	<input type="checkbox"/> Cable Puller	<input type="checkbox"/> Capping
<input type="checkbox"/> Vacuum	<input type="checkbox"/> Polishing	<input type="checkbox"/> Food	
<input type="checkbox"/> Others			
Conveyor speed:	m/s	Max. acceleration/deceleration	m/s ²
Material to be conveyed:			
Weight of load on the belt: kg			
Material of belt Guidance/friction partner:			
Does the belt run in			
<input type="checkbox"/> one direction only		<input type="checkbox"/> bi-directionally?	
Number of Pulleys:	Diameter of Pulleys:	Counter flexion Diameter:	
Material of Pulleys:	Omega drive: yes/no		
What best describes the cover need?			
<input type="checkbox"/> High friction	<input type="checkbox"/> Low friction	<input type="checkbox"/> Easy of release	<input type="checkbox"/> Shock Absorption
<input type="checkbox"/> Compressibility	<input type="checkbox"/> Others		
Does the cover require a specific thickness?			
Does the cover have a min/max thickness tolerance?			
Does the belt have contact with water?			
If yes	<input type="checkbox"/> Bath	<input type="checkbox"/> Humidity	
Does the belt have contact with salts, lactic acids, oils, UV radiation or Abrasive materials like sand/dust/crystals?			
If yes please add kind of contacts and/or material:			

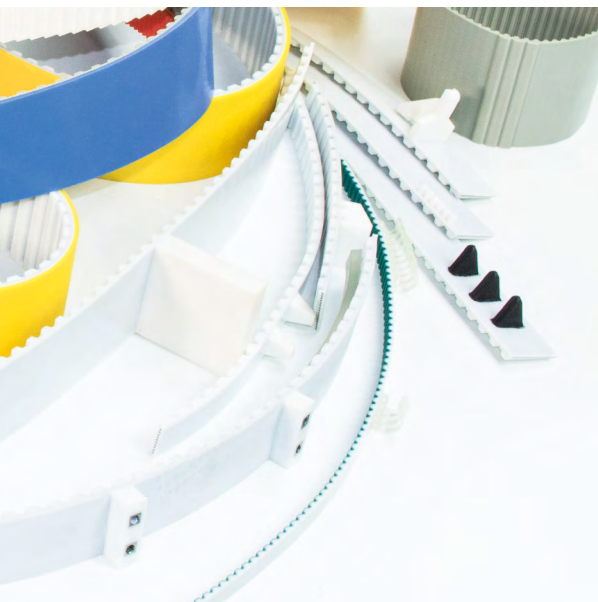

MODIFICATIONS

CUSTOM COVER MODIFICATIONS

CLEATS

MEGAC4T

FALSE TEETH

PROGRESSIVE PIN JOINT (PPJ)

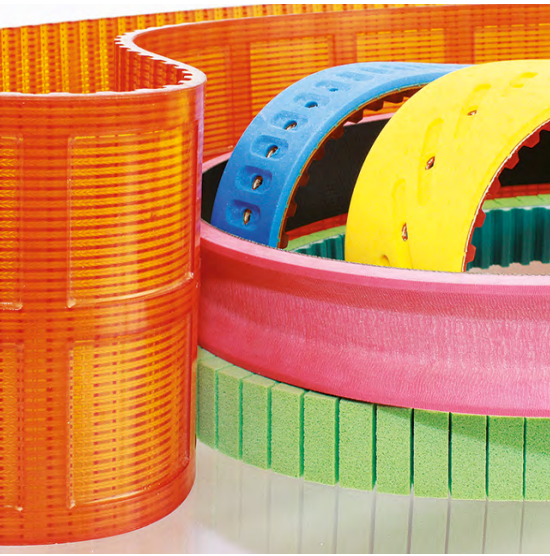

MODIFICATIONS

CUSTOM COVER MODIFICATIONS

Process enhancements, skilled personnel and ongoing capital equipment investments enable Megadyne to stay at the forefront of new design developments and solution delivery to customers across the wide spectrum of industries we serve. Let a Megadyne Technical Sales Representative or Application Engineer create the right belt to deliver optimum performance for your application.

In addition to materials and process selection of the base belt, Megadyne can fully customise our belts with the following machined modifications:

- Custom shapes
- Grinding
- Notching/Knife Cut
- Fabric added to the toothside of belt
- Vacuum Countersinks
- Holes/Perforations
- Pockets
- Slots
- Saw Tooth
- Grooves
- Water Cut

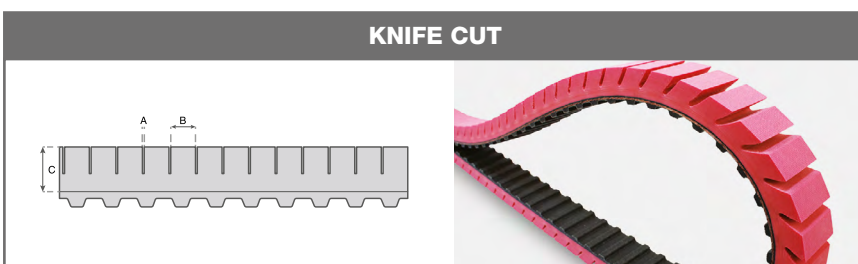
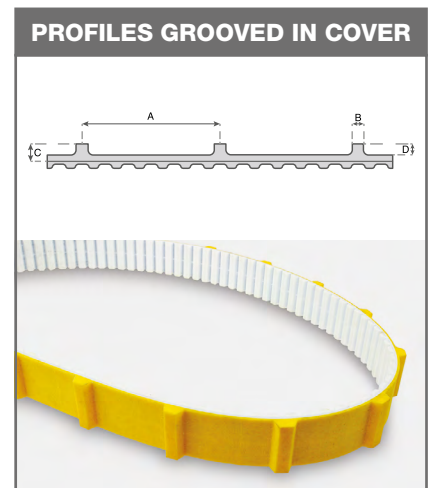
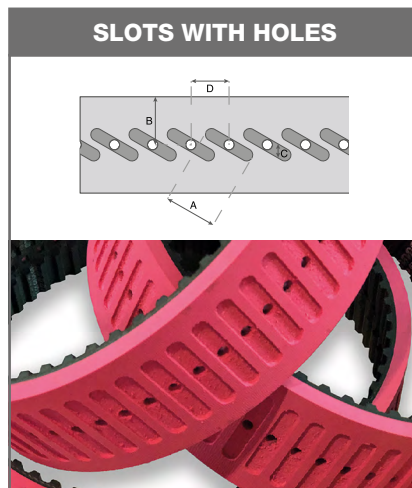
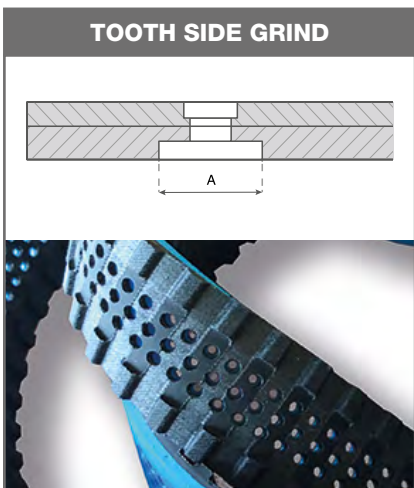
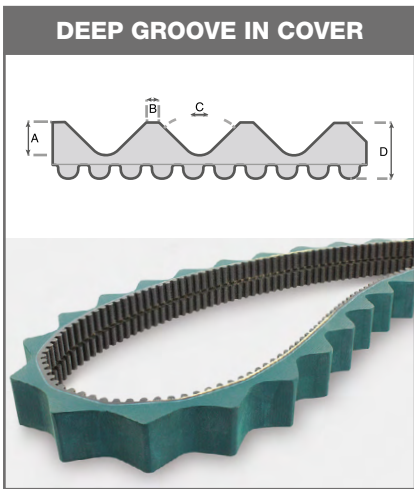

CONTACT MEGADYNE FOR OTHER CUSTOM OPTIONS AND MODIFICATIONS TO FIT YOUR PROCESS/APPLICATION.

ENGINEERED & SPECIALTY BELTS



CLEATS

FLIGHTS OR PROFILES

Cleats, also known as flights or profiles, are practical additions to urethane belts to assist in applications where product separation, sortation, actuation, or pushing. Cleated timing belts are commonly found in application areas where pick and place must be timed for production line accuracy.

MEGALINEAR and MEGAFLEX timing belts can be customised with profiles welded, casted out of a mould or even grinded from over-thickness on the backside of the belt.

All cleats, whether injection moulded or CNC machined are made with high-quality thermoplastic polyurethane.

Cleat Design is determined by the application requirements of the cleat and the size of the product required. Using our flexible production capabilities, Megadyne can design any cleat shape to meet the specific requirements of the customer:

- CNC machined from thermoplastic PU sheet or grinded out of over-thickness
- Injection moulded or casted which are manufactured in our own tool building facilities to guarantee fast service.

The cleats are attached by using high-frequency vibration, high-friction, hot blade, and infrared-welding or even chemical bonding. When made by grinding or casting, the cleats are homogenous.

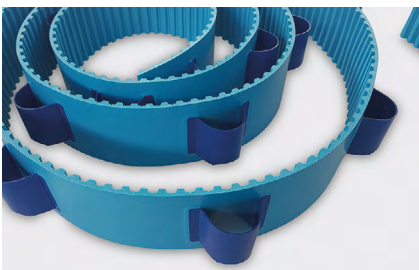
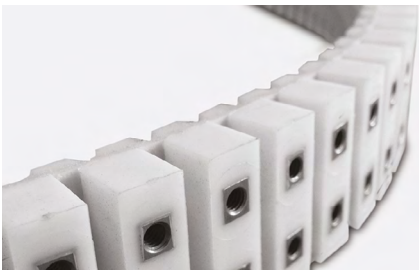
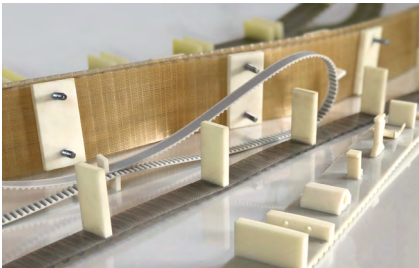

CLEAT MATERIALS FOR THERMOPLASTIC BELTS

Our standard cleat is made with 92° ShA white polyurethane. This material is also used to produce MEGALINEAR and MEGAFLEX timing belt.

Cleats can also be supplied in different durometers and in alternative urethane colours. In applications where a hard and wear-resistant cleat is required, a harder durometer like 96 ShA can be provided. Additionally, Megadyne can mould glass fibre reinforced polyurethane.

In addition to our standard 92 ShA or harder 96 ShA urethane, Megadyne can provide EU Food compliant, FDA compliant blue, or transparent polyurethane for the food and pharmaceutical industry with a hardness of 85 ShA. Blue cleats made with the same FDA material as our blue belt are available to ensure materials compatibility for use in food applications.

Selection of the cleat material can be also dependant on the environment temperature (at low ambient temperatures low hardness is recommended). In general, individual cleat colours deviating from the standard can be produced according to indicated RAL number and under consideration of a minimum quantity.

Cleats can be covered by fabrics or made with dual material, like elastomers with metal inserts.

Cleats can be also reworked mechanically out of homogenous belt body. This is especially for high-quantity of cleats with a low pitch distance a very effective way to manufacture cleated belts. As this kind of process is made out of belts produced in over-thickness, the cleat height is limited and depends on the belt type and pitch.

LOOKING FOR CUSTOM CLEATS?

If you require a unique shape cleat for your specific product application, we can help.



Contact our team for more information.

ENGINEERED &
SPECIALTY BELTS

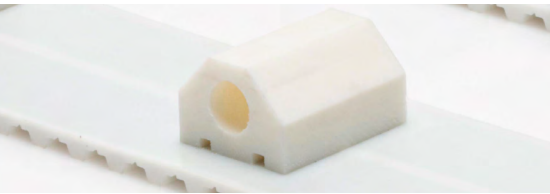

CLEATS

FLIGHTS OR PROFILES

CLEAT MATERIALS FOR THERMOSET BELTS

For MEGAPOWER PU belts, cleats are cast in homogeneous fashion as the timing belt is moulded. For this, special tooling is needed. Quantity is a critical factor in determining if this process is right for you. The hardness of the base belt and the cleat is for this kind of manufacturing the same and depends on the selected Thermoset PU.



This kind of processing allows a more accurate tolerance of the cleat position and allows even blind holes in cross direction without an additional reworking.

DIMENSIONAL TOLERANCES

The dimensional accuracy of injection-moulded cleats depends on the shrinking behaviour of the selected polyurethane, the size and shape of the cleat.



- Injection-moulded cleats have a general tolerance of up to ± 0.3 mm.
- Mechanically processed cleats have a general dimension tolerance of up to ± 0.5 mm.
- Smaller tolerances can be achieved depending on the cleat material and must be requested case by case.

METHODS USED TO WELD CLEATS

HIGH-FREQUENCY, INFRARED & HOT BLADE

Depending on the shape and quantity of cleats to be welded, thermoplastic cleats can be welded using one of several options. When heating the cleat and base belt, polyurethane melts and creates a bead around the welding point. To avoid any negative impact of this bead on the transport side it will be cleaned accordingly to secure the precise positioning of the transport goods.

In some specific cases, a suitable tool is needed to fully remove the welding bead. The cleaning of welding beads on cleats with glass-fibre reinforcement should be avoided in general. Additional to the bead the welded cleat loses height during the welding process. This height loss is called burn-off and is taken into consideration during cleat design and production.

COLD WELDING (CHEMICAL BONDING)

During chemical bonding, the thermoplastic polyurethane cleat is permanently connected with the thermoplastic polyurethane base belt. Chemical bonding is preferably used for flat, round, and thin-walled cleats, as in contrary to the hot welding no material melts off, no welding beads and no burn-off occurs. Glass-fibre reinforced polyurethanes cannot be chemically bonded.

SPECIAL CLEAT DESIGNS

Megadyne can use components made from food-contact approved conveyor belts as cleats, applied with high-frequency technology to TPU timing belt. This hybrid construction is perfect for food applications, such as fruit conveying.

More information and profiles available online in our Technical Manuals:

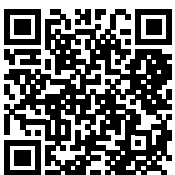

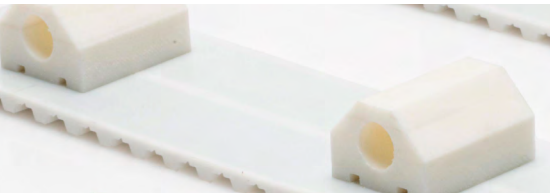

CLEATS

BELT WORKSHEET

Application:		
QUANTITY OF CLEATS AND BELTS NEEDED:		
Base Belt Substrate: <input type="checkbox"/> MEGALINEAR <input type="checkbox"/> MEGAFLEX <input type="checkbox"/> Other:		
Cleat colour:	Cleat material:	
FDA: <input type="checkbox"/> yes <input type="checkbox"/> no		
Belt pitch:	Belt length:	Belt width:
Belt cord:		
Pulley diameter(s) or # of teeth and pitch:		
Cleats spacing:		
Desired cleat dimensions:		
IF THE CLEATS ARE IN GROUP, PLEASE SPECIFY:		
Quantity of cleats per group:	Spacing of cleats inside the group:	
Spacing of the groups:		
Sketch cleat(s) design with all relevant dimensions:		
<div style="background-color: #f0f0f0; border: 1px solid #ccc; width: 100%; height: 100%; display: flex; align-items: center; justify-content: center;"> </div>		

Some cleats Examples:

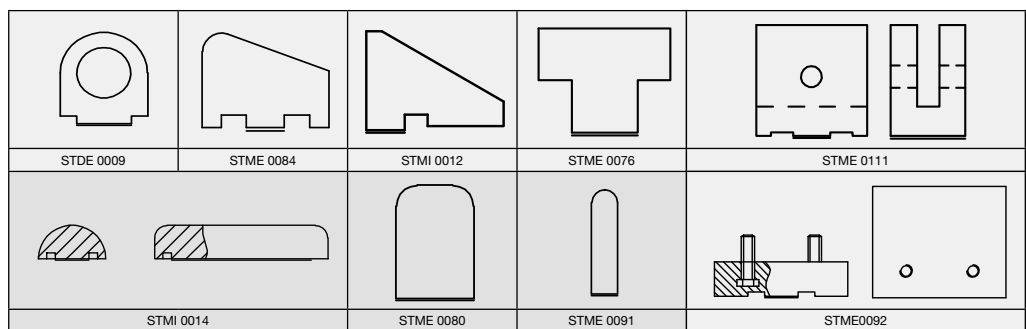

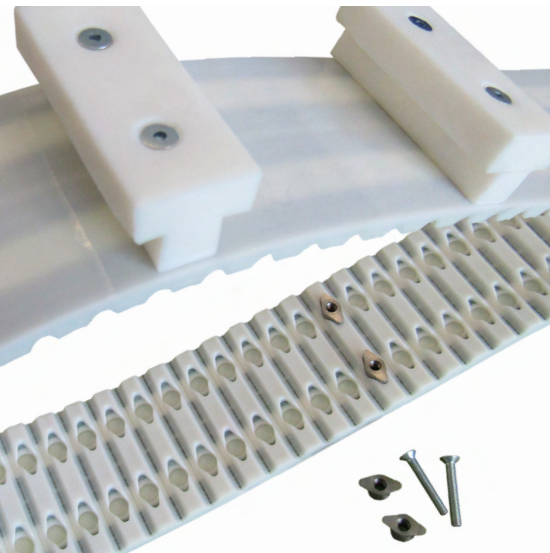

CLEATS

MEGAC4T & FALSE TEETH

Our False Tooth product is designed to provide an easy mechanical attachment option for placement of cleats and other profiles and shapes to H, AT10, and AT20 pitches. False Teeth can be added to MEGALINEAR open-ended, MEGAFLEX truly endless thermoplastic, and MEGAPOWER urethane timing belts.

False Teeth with mechanical attachments can be used to offer flexibility of adjustment and positioning in applications where sortation, actuation and product separation are needed such as in pick and place systems, inserting and cartoning machines found in the packaging industry. Megadyne's False Tooth attachments provide a method to reposition or replace broken cleats without the need to replace belts, thus saving time and money.

Additionally, False Teeth used to mount mechanical attachments can be a solution in applications where the forces placed against conventional weld-on cleats are too high and not robust enough to withstand the loads placed on them, which can lead to pull-off failure.

Megadyne standard False Tooth's material is AISI 304 stainless-steel. Contact Megadyne to discuss other material options.

MEGAC4T

A SPECIAL SOLUTION IS BECOMING STANDARD!!!

The fastening system of the exchangeable profile in the tooth of the belt allows a quick assembly and makes the belt extremely versatile — the same belt can be equipped with different profiles for individually transported goods without de-installation. The highly variable profile pitch will standardise any application.

ADVANTAGES OF MEGADYNE FALSE TEETH:

- Easy installation and removal of cleats
- Precise profile positioning
- Cost reduction in assembly and maintenance:
 - No removal of belt needed to replace cleats
- Different cleat materials can be used
- Stainless-steel false teeth suitable for food & pharmaceutical industry
- Available with NFT/NFB, FDA Urethane and with steel aramid or stainless-steel cords. Self-tracking belts can also be provided.

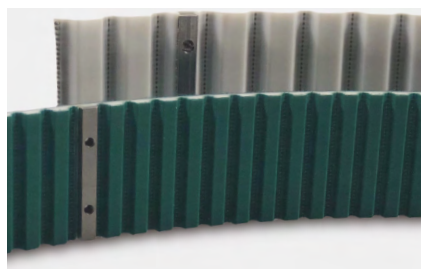

AVAILABLE ON FOLLOWING BELTS:

PITCH AND WIDTH	HOLE SPACING (mm)	# OF HOLES	DIAMETER OF HOLE (mm)	POST THREAD SIZE
H50	25	2	6 +/-0.3	M4
25AT10	12 +/-0.2	2	6 +/-0.3	M4
32AT10	20 +/-0.2	2	6 +/-0.3	M4
50AT10	25 +/-0.2	2	6 +/-0.3	M4
75AT10	25 +/-0.2	3	6 +/-0.3	M4
100AT10	25+/-0.2	4	6 +/-0.3	M4
25AT20	-	1	7.5 +/-0.3	M5
32AT20	20 +/-0.2	2	7.5 +/-0.3	M5
50AT20	25 +/-0.2	2	7.5 +/-0.3	M5
75AT20	25 +/-0.2	3	7.5 +/-0.3	M5
100AT20	25 +/-0.2	4	7.5 +/-0.3	M5

ENGINEERED & SPECIALTY BELTS

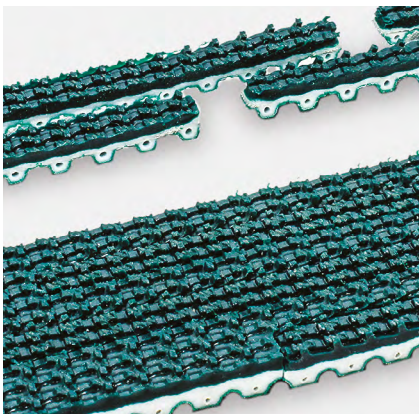
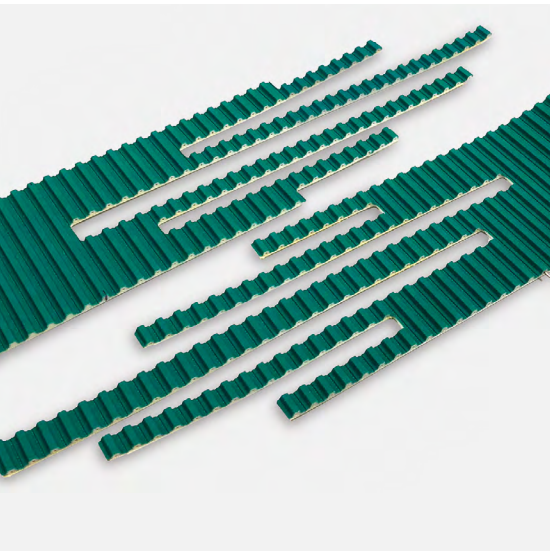

MODIFICATIONS

PROGRESSIVE PIN JOINT SYSTEM (PPJ)

Megadyne's Progressive Pin Joint (PPJ) system provides a simple, reliable method of placing a timing belt on an application without the need to tear apart the conveyor or join the belt endless online. PPJ is a perfect option for parallel path belts where the load being moved is spread across several belts. Installation and replacement of belts is fast, simple and cost-saving.

PPJ IS AVAILABLE FOR THE FOLLOWING BELT TYPES:

BELT TYPE	WIDTH (mm)	BELT TYPE	WIDTH (mm)
T10/AT10	25	T20/AT20/ATG20	75
TG10 K6	25	MTD8/RPP8	20
T10/AT10	32	MTD8/RPP8	30
T10/AT10	50	MTD8/RPP8	50
T10/AT10	75	MTD8/RPP8	85
T10/AT10	100	MTD8/RPP8	100
TG10/ATG10	50	MTD14	55
T20/AT20	32	MTD14	85
T20/AT20	50	H075	19.05 (0.75 in)
HG150	38.1 (1.5 in)	H100	25.4 (1 in)
HG200	50.8 (2 in)	H200	50.8 (2 in)

For different widths please consult Megadyne.

AVAILABLE PITCHES AND STEEL CORD TYPES:

STANDARD	HIGH FLEX	STAINLESS
T10, AT10, TG10 ATG10, T20 AT20, MTD8, RPP8	T10, AT10 T20, AT20	T10, AT10 TG10, ATG10, MTD14

If Kevlar® cords are required please consult Megadyne.

AVAILABLE COVERS ON PPJ BELTS:

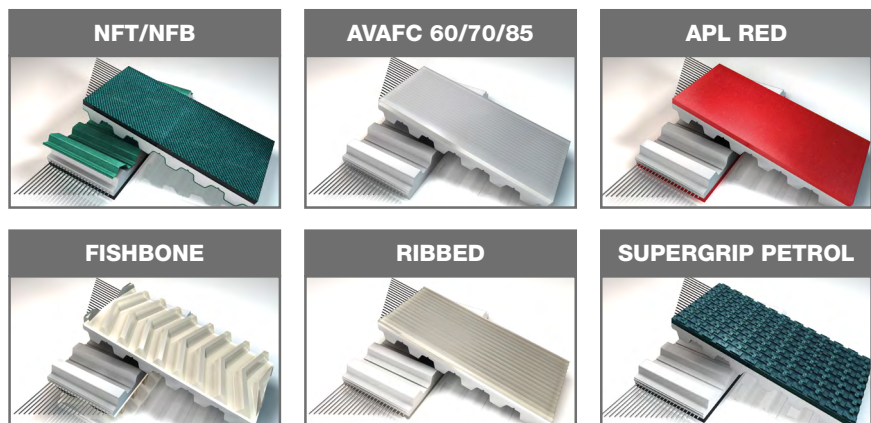

Contact Megadyne to discuss other cover material options.

ENGINEERED &
SPECIALTY BELTS



ENGINEERED SOLUTIONS

ENGINEERED BELTS
HYBRID BELTS

ENGINEERED &
SPECIALTY BELTS

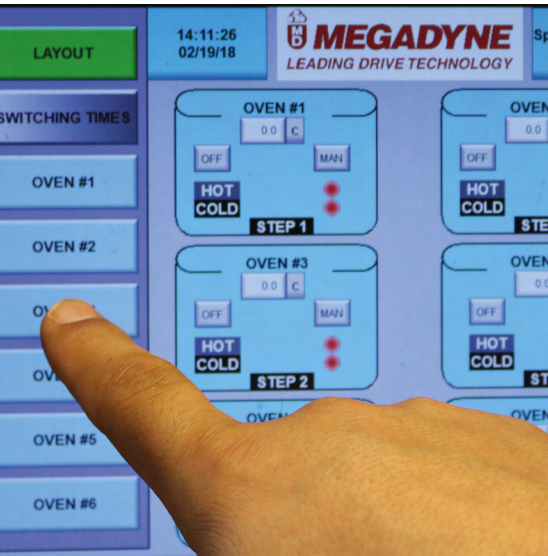

ENGINEERED SOLUTIONS

ENGINEERED BELTS

Megadyne offers several advanced engineered elastomers and processes to produce high-precision belts for applications within packaging, business machines, aerospace and medical applications.

These elastomers offer performance benefits ranging from high-temperature resistance to outstanding flex fatigue to electrical insulation. Elastomers within this class can be spun cast, moulded, wrapped or ultrasonically welded to deliver the performance needed in the toughest applications.

MATERIAL	FILM BELTS		SPIN CASTING	
	MYLAR®	KAPTON®	HYTREL®	URETHANE
HARDNESS (SHORE A)	N/A	N/A	30/40/50/60/70	60/80
COLOURS	○	●	●	● ● ● ● ● ●
THICKNESS RANGE	0.003-0.014"	0.001-0.005"	0.010 to 0.040"	0.020 to 0.125"
WORKING TEMP RANGE °F (°C)	-94/+320 (-70 /+160)	-148/+716 (-100 /+380)	-40/+212 (-40 /+100)	-4/+176 (-20 /+80)
WATER RESISTANCE	Good	Good	Good	Good
ABRASION RESISTANCE	Very Good	Very Good	Good	Good
OIL RESISTANCE**	Good	Very Good	Very Good	Good
FOOD CONTACT APPROVED	Yes	Yes	No	No
OTHER BENEFITS	Electrical Insulation	UL94 VO Fire Rating	High Flex Fatigue Resistance	Hydrolytic Stability

Mylar®, Kapton® and Hytrel® are registered trademarks of DuPont

ENGINEERED & SPECIALTY BELTS

ENGINEERED SOLUTIONS

PHOTOS

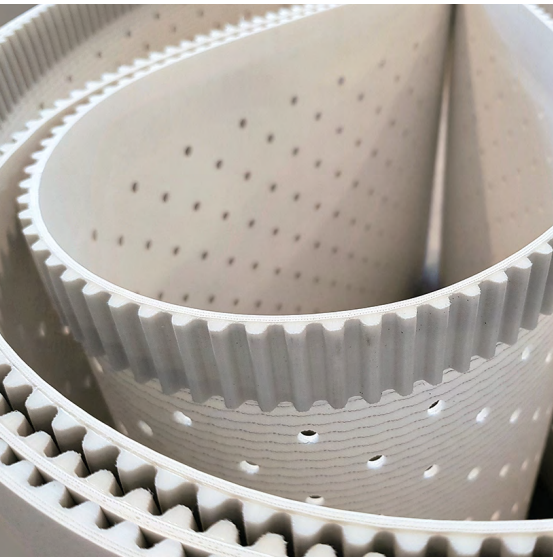

URETHANE W/ TRACKING GUIDE



TRULY ENDLESS SILICONE



TRULY ENDLESS KAPTON®



TRULY ENDLESS HYTREL® COATED WITH SILICONE



REINFORCED SILICONE WITH GUIDE



FOAM



TRULY ENDLESS URETHANE WITH TABS



TRULY ENDLESS DUAL DUROMETER URETHANE AND NATURAL RUBBER



ENGINEERED &
SPECIALTY BELTS

ENGINEERED SOLUTIONS

HYBRID BELTS

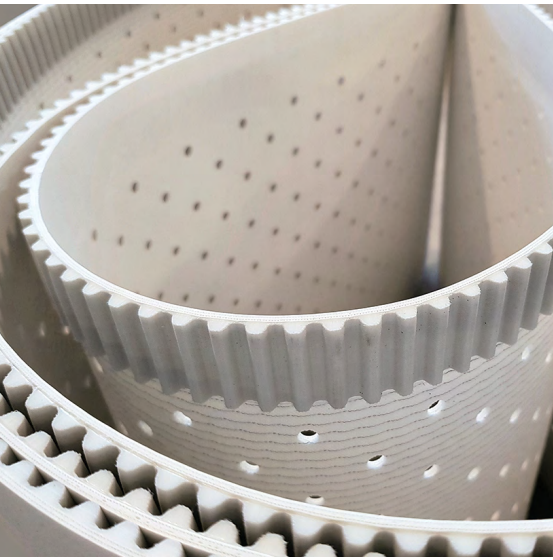

Hybrid belts deliver synchronisation and conveying in one belt design. Starting with conveyor belts, we add extruded timing belts to provide precise positioning and accurate tracking. We have successfully implemented the Hybrid solution in several markets & industry sections, which allows us to enlarge our product portfolio.

Hybrid, Hybrid Plus and Hybrid Pro belts are available with polyurethane or silicone covers and available with the following urethane belt pitches- H, T5, T10, MTD5, MTD8M, STD8M, T20, T5 BLUE FC, T10 BLUE FC, AT5, AT10, and AT20 with a base surface of Fabric and Elastoflex. Additionally, with the high-variation and flexibility of our Synthetic and Conveyor portfolio and with the enormous reworking capabilities such as hole perforating and cleat & rope welding we have the perfect solution for any type of application.

TYPE	HYBRID		HYBRID PLUS		HYBRID PRO PLUS	
CONVEYOR BELT	PUCON, SILCON, FABCON, ELASTOFLEX		PUCON, SILCON, FABCON, ELASTOFLEX		PUCON, SILCON, FABCON, ELASTOFLEX	
CONVEYOR BELT FABRIC	Rigid, Light Rigid and Flexible Polyester		Rigid, Light Rigid and Flexible Polyester		Rigid, Light Rigid and Flexible Polyester	
MEGALINEAR BELT TYPE AND PITCH	H, T5, T10, MTD5, MTD8M, STD8M, T20, T5 BLUE FC, T10 BLUE FC, AT5, AT10, AT20		H, T5, T10, MTD5, MTD8M, STD8M, T20, T5 BLUE FC, T10 BLUE FC, AT5, AT10, AT20		QST5, QST8, QST14	
MEGALINEAR CORD TYPES	Kevlar®, No cord		Kevlar®, No cord		No cord	
MEGALINEAR DUROMETER/COLOR	92A	● ● ● ● ●	92A	● ● ● ● ●	92A	● ● ● ● ●
MEGALINEAR NFT	Yes		Yes		Yes	
# OF MEGALINEAR BELTS	One-centered, belt bottom		Two or more as per customer design		Two, belt edges	
MAX BELT WIDTH (mm)	1000		2000		2000	
ADVANTAGES	Driven speeds up to 500 m/min. Precision positioning Energy savings				Enables compact conveyor designs Low noise level	
INDUSTRIES						

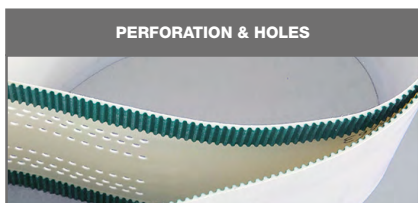

PERFORATION & HOLES

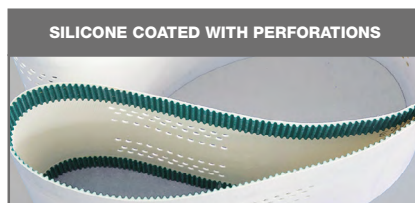

SILICONE COATED WITH PERFORATIONS

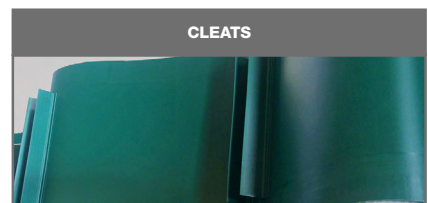

CLEATS

ENGINEERED & SPECIALTY BELTS

ENGINEERED SOLUTIONS





HYBRID BELTS

Hybrid Vacuum is a unique design where synchronization, and an open mesh (used for drainage or vacuum), are combined into one belt design.

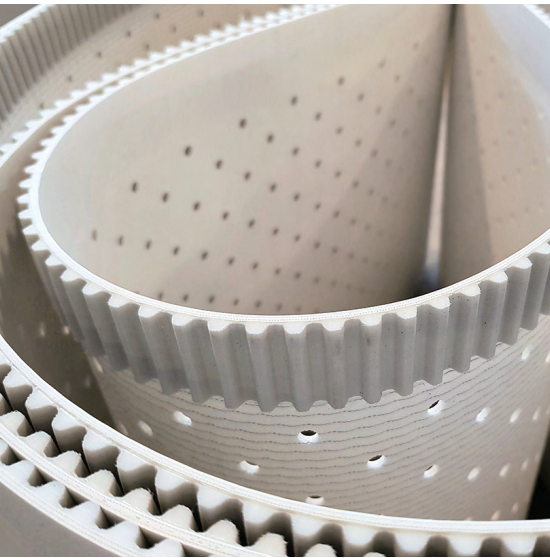
SPIRAFLEX

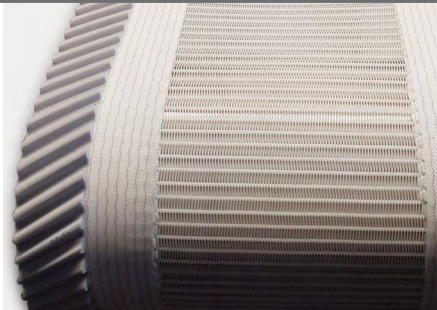
Spiraflex grid conveyor belts are used in diaper manufacturing and to produce other hygienic products as-well-as the transportation of fresh pasta and licorice. In the Food Industry, Spiraflex can replace traditional metal wire mesh conveyor belts. In the case of conveying fresh pasta or dough, Spiraflex allows the steam sprayed by the machinery inside a tunnel, to eliminate the residual flour of the product. In the case of licorice transport, Spiraflex resists steam used to get a glossy finish on the surface of product.



TYPE	HYBRID VACUUM	SPIRAFLEX
CONVEYOR BELT		
CONVEYOR BELT FABRIC	Polyester open mesh with PUCON	Spiraflex
MEGALINEAR BELT TYPE AND PITCH	Rigid polyester	Polyester with reinforced edges
MEGALINEAR CORD TYPES	H, T5, T10, MTD5, MTD8M, STD8M, T20, T5 BLUE FC, T10 BLUE FC, AT5, AT10, AT20	
MEGALINEAR DUROMETER/COLOR	Kevlar®, No cord	
MEGALINEAR NFT	92A	—
# OF MEGALINEAR BELTS	Two, belt edges	
MAX BELT WIDTH (mm)	Yes	
ADVANTAGES	2000	2000
INDUSTRIES	Driven speeds up to 500 m/min. Precision positioning Energy savings Enables compact conveyor designs Open mesh allows vacuum or drainage	Excellent suction properties Customization Low weight
		

ENGINEERED &
SPECIALTY BELTS

The data and information contained in the present catalogue are updated to the date of the catalogue's printing. Ammega Italia S.p.A. reserves the right to modify the specifications, performances and other information relating to the belts described in the present catalogue, at any time at its own discretion, without any prior notice.

For updating refer to our website www.megadynegroup.com.

Technical specifications, performances and other information provided in the present catalogue are indicative and do not bound Ammega Italia S.p.A. unless such specifications, performances or other information are expressly agreed in the agreement with the customer.

We also recommend to read carefully the following documents on our web site www.megadynegroup.com:

- Ammega Italia S.p.A. General Conditions of Sale (comprising the warranty)
- Theoretical Belt Life
- Drive Components: Storage, Installation, Maintenance and Troubleshooting Handbook
- Belts standard use condition and temperature.

Copyright Notice: Ammega Italia S.p.A. copyright. All rights reserved.

Ammega Italia S.p.A. is and shall remain the owner of all rights on drawings, technical specifications and any other information contained in the present catalogue or otherwise communicated by Ammega Italia S.p.A. to the customer.

The customer shall not disclose such information to third parties or use such information for purposes different from the definition of the order to Ammega Italia S.p.A., unless upon prior written authorization of Ammega Italia S.p.A..



MEGADYNE S.p.A.
ITALY - MATHI

Discover Your Local Contacts

The local partner of choice
for sustainable power transmission belting solutions
around the globe.



General contact information:

Megadyne

Via Trieste, 16
Via S. Lucia 114 - 10075 Mathi (Torino)
Italy



Scan the QR code
and find your local
contact

